

ACO Solutions for Hotels and Resorts

Helping create signature hotels worldwide





Helping create signature hotels worldwide

Our system solutions function in both directions: protecting people from water – and vice versa. Our products are frequently found in, on and around many stunningly beautiful and spectacular buildings worldwide.

Planners and architects know they can rely on ACO's competence in situations where not only design quality but also extreme ruggedness, functionality and safety are a top priority.

In this book you will find application solutions for different areas in your project, meeting the major challenges of the design, professional expertise and inspiration projects from around the world. In addition, our dedicated team and technical services are available to help you create your signature hotel.

*Explore inspirational project solutions
around the world!*



ACO has years of international experience providing system solutions for hotels. Our extensive portfolio of products and services for the following applications:

- ✓ **Roof, Terrace & Facade**
- ✓ **Kitchen**
- ✓ **Bathroom**
- ✓ **Entrance & Lobby**
- ✓ **Spa & Pool**
- ✓ **Basement**
- ✓ **Parking**
- ✓ **Garden & Landscaping**

8 applications for hotels



Content

ACO Group	7		
Roof, Terrace & Facade	9	Basement	79
Line drainage	15	Lightshafts	85
Gravity and syphonic gullies	17	Windows	87
ACO GM-X pipe system	19	Therm block	89
		Backflow preventers	91
Kitchen	21		
Hygienic box channels	27	Parking	93
Hygienic gullies	29	Line drainage with design gratings	99
Pipes	31	Kerbs with integrated drainage	101
Wall protection	33	High capacity slot drainage system	103
Grease separators	35	Monolithic slot channels	105
Wastewater lifting plants	37	Line drainage for parking decks	107
		Surface water treatment for light liquids	109
Bathroom	39		
Shower line drainage	45	Garden & Landscaping	111
Shower point drainage	51	Ground stabilisation systems	117
Supplementary components	53	Modular infiltration system	121
		Tree protection	123
Entrance & lobby	55	Access covers	125
Entrance matting systems	61	Manhole covers	127
Access covers	63	Point drainage	129
Spa & Pool	65	ACO reference projects	131
Channels with gratings	71		
Slot channels	73		
Custom made line drainage	75		
Floor gullies	77		



ACO Academy

ACO Academy – sharing knowledge equals multiplying know-how

ACO's strength: we consider communication to be a crucial success parameter. With intense knowledge management, we harness the opportunities for linking up creativity, know-how and experience worldwide, and share this expertise with clients and partners.



Iver Ahlmann and Hans-Julius Ahlmann, managing partners of the ACO group



The historic building on the banks of the Eider river, the symbolic headquarters of the ACO Group



ACO is the organizer of one of the largest exhibitions of modern art in Europe NordArt www.nordart.de



Our local teams are always available to support your project during the design, execution and operation stage.



ACO. creating the future of drainage

ACO is the world leader in drainage technology

We see our market through the eyes of our customer. We like to keep in close contact with them to impress them with the best products and services.

ACO creates solutions for tomorrow's environmental conditions

Global climate change is causing more and more frequent extreme weather events such as droughts and heavy rainfall. We develop innovative system solutions to weather these events.

ACO creates passion for top performance

We support those who act courageously. We enjoy working together creatively across all cultural barriers. In our philosophy, setbacks are an opportunity to become even better.

Roof, Terrace & Facade

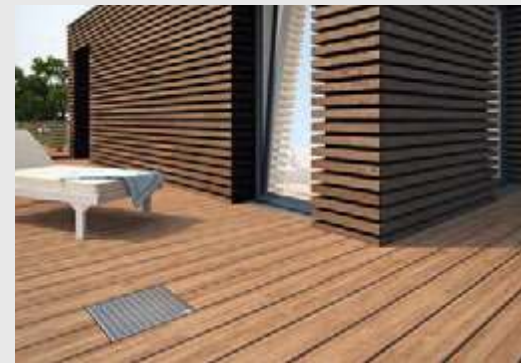

Roof, Terrace & Facade

Roofs encompass the upper building boundary and their design is an important part of the overall structure of the building. Planning errors in roof drainage can lead to, in extreme cases, the collapse of the roof.

This can be dangerous and lead to the destruction of the entire property or lowering of its value. There are many aspects to consider when designing the roof drainage system. It's important to take into account the local climate as well as the norms, regulations, architectural and construction requirements.



Heavy rainfall

Flat roofs are sensitive architectural areas. Therefore a professional planning of the drainage system is particularly important. If rain falls on the flat surface, large amounts of water can quickly accumulate. To protect the building, a drainage system is required. Heavy and continuous rainfall must be considered to ensure the structure of the roof.

Barrier free movement

Modern public buildings must provide barrier free movement and accessibility to all internal and external areas of the building. In order to accommodate the high standards of architects and planners, drainage of facades and terraces should be perfectly integrated with the surrounding surface. Consequently, the height of the channels must be adjusted with mm-accuracy to the floor level. They should also prevent any water accumulation or splashing during heavy rainfall.

Fire Protection

All countries set general requirement about fire safety and protection. Therefore roof installation must be set up, modified and maintained in such a way that public safety and order are not jeopardized.

Roof constructions must be arranged, erected, modified and maintained in such a way as to prevent the occurrence of a fire and the spread of fire and smoke.



European norms and regulations

- **EN 1253** - Roof gullies for buildings.
- **EN 12056-3:2000** - Gravity drainage systems inside buildings. Roof drainage, layout and calculation
- **EN 13501** - Fire classification of construction products and building elements. Classification using test data from reaction to fire tests





Barrier free surface and optimal protection for the building boundaries

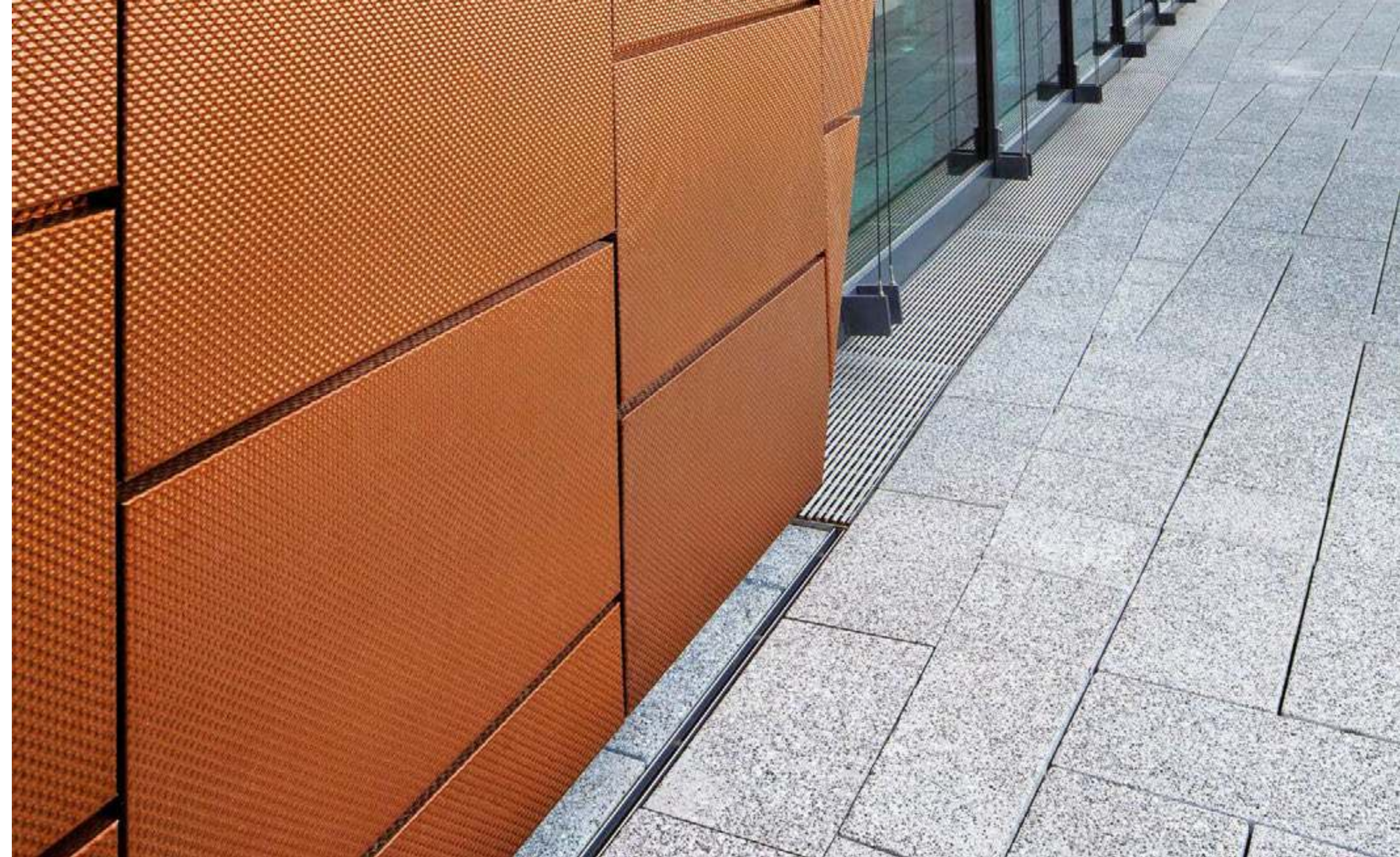

Flat roofs have many advantages, but they have to master a huge static challenge. When it comes to planning and execution, safety, fire protection and effective roof drainage are top priorities. ACO offers functional solutions that are specially adapted to the flat roof area of use and ensure optimum drainage of rainwater. For smaller areas, systems for gravity drainage are suitable. On large roofs over 150 m² per gully, drainage systems with negative pressure are preferred. ACO offers products in the materials cast iron and stainless steel-A1 class fire protection materials. There are also special solutions for green roof, attic and emergency drainage. When planning the correct flat roof drainage and the hydraulic calculation of the pressure flow systems, ACO supports you with the latest standard-compliant design software and a high level of practical knowledge. The planning and execution of façade drainage, balcony drainage or terrace drainage in residential construction demands the highest degree of individual adaptation and design from architects

and engineers. The areas must be sustainably protected from the weather influences, including rainwater, wind, snow piling and heat protection. In addition to that ACO has developed a comprehensive range of solutions in compliance to functional and design requirements, including contemporary trends for barrier free surfaces and secondary drainage. Our professional services and flexible production process enable the creation of individual solution to face any project challenges.

ACO Fire protection

According to the European regulations for fire protection for flat drain roof flat roof gullies with fire protection insert are needed to prevent the transfer of smoke and fire in the building area. In case of fire the special developed material in the function device of the Jet gully blocks the opening in the roof gully to prevent the breakdown of fire and smoke.



ACO System solutions for roof, terrace & facade



ACO Profiline



ACO Jet



ACO Spin



ACO GM-X



Roof Terrace & Facade
 Kitchen
 Bathroom
 Entrance & Lobby
 Spa & Pool
 Basement
 Parking
 Garden & Landscaping

ACO Profileline

Line drainage

Product overview

The Profileline system is designed to be positioned above the roof or balcony membrane. It drains water directly from the pavement surface or down a façade via the grate. Perforations in the side walls of the channel allow water that has percolated through the pavement or green roof materials, to drain. It then guides this water to the roof or balcony drain.

If the roof or balcony drain cannot be ideally situated, drainage ducts can be used to discretely direct the water to the required location.

The access grate can be used over the rainwater outlet to provide access for maintenance.

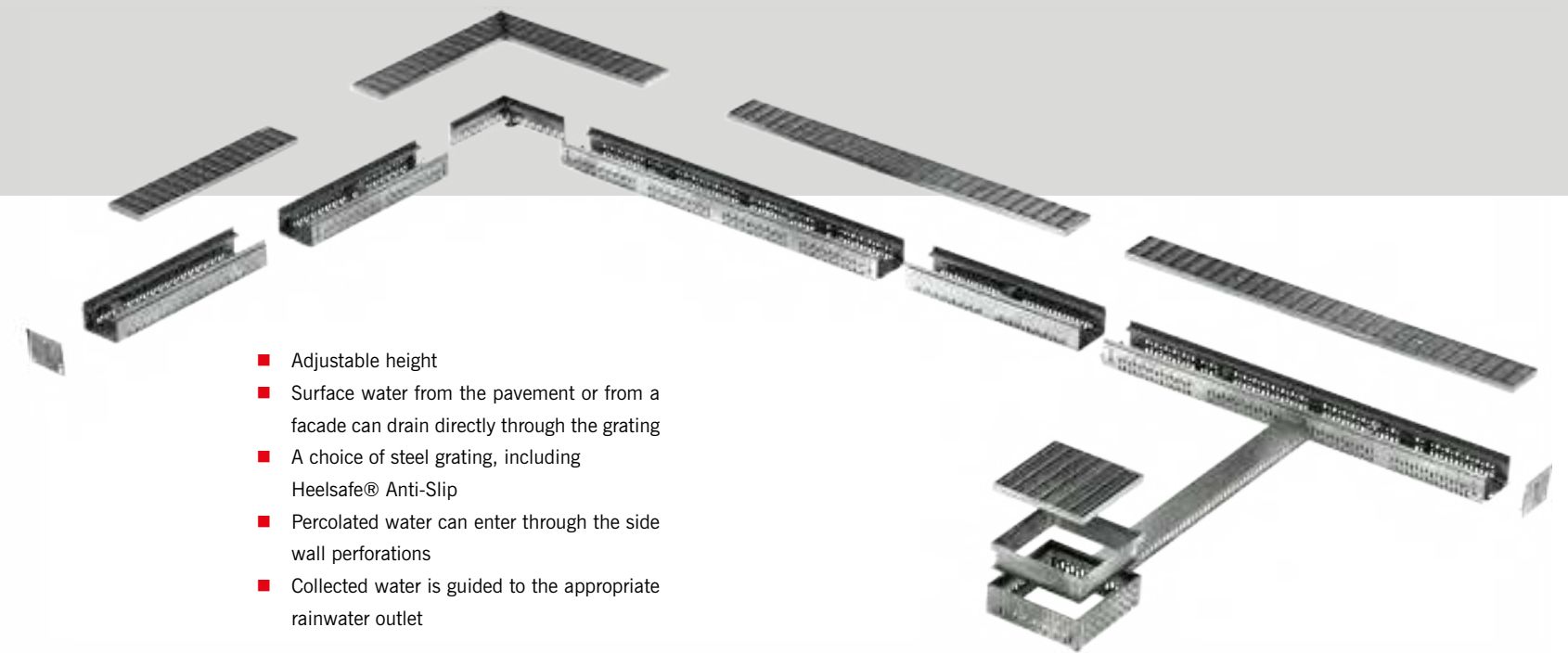
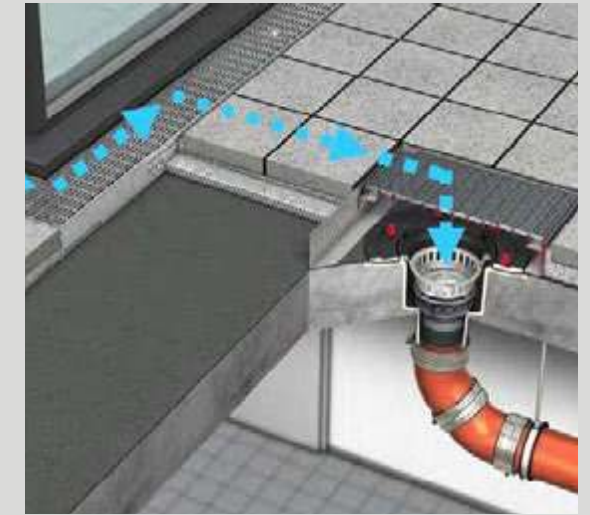
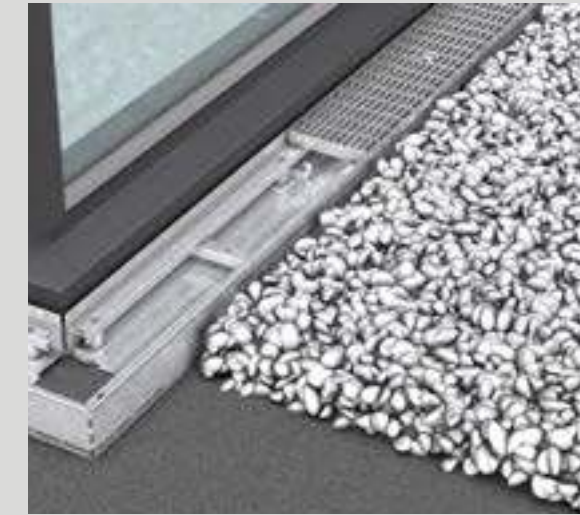

- Adjustable height
- Surface water from the pavement or from a facade can drain directly through the grating
- A choice of steel grating, including Heelsafe® Anti-Slip
- Percolated water can enter through the side wall perforations
- Collected water is guided to the appropriate rainwater outlet

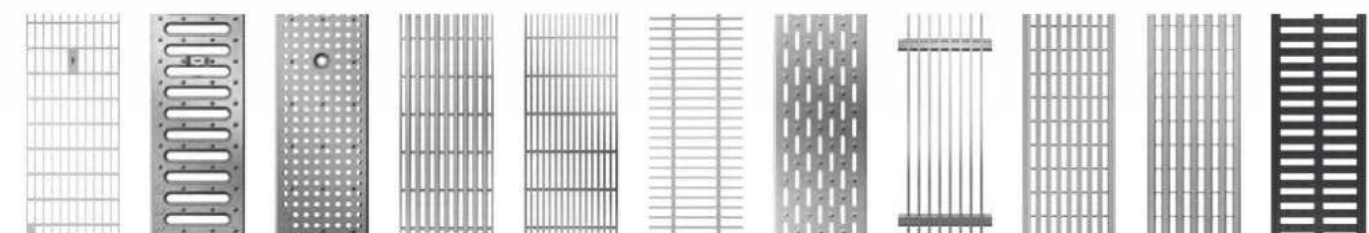



Roof Terrace & Facade
 Kitchen
 Bathroom
 Entrance & Lobby
 Spa & Pool
 Basement
 Parking
 Garden & Landscaping

ACO Jet & ACO Spin

Siphonic & Gravity roof drainage

Product overview

Flat roofs are sensitive architectural areas. That is why it is especially critical to plan their drainage systems professionally. When rain falls onto a flat roof, large volumes of water can collect rapidly. Unless there is an effective way of draining off precipitation, this can lead to excess loads being placed on the building's structure. ACO offers functional solutions which are specially designed for flat roof areas and which ensure the water is drained effectively. For smaller surfaces, gravity drainage systems are the solution. For larger roofs of 150 m² per gully or more, siphonic systems can be installed.



ACO gravity roof drainage - Spin

ACO siphonic roof drainage- Jet

- Material - cast iron and stainless steel
- One-piece or two-piece gullies
- Suitable for main and emergency drainage
- Individual components of the gullies such as gratings, top sections and gully bodies
- With or without insulation
- Vertical angled outlets: 90° / horizontal angled outlets 1,5°
- Various accessories
- Non-flammable A1, according EN 1253-2

- Material - cast iron and stainless steel
- One-piece or two-piece gullies
- Increased drainage performance level
- Specially designed flat roof drains, configured to work with completely full pipes (degree of fill h/d 1.0).
- Special components used to prevent vortices forming.
- Vertical angled outlets: 90°
- Non-flammable A1, according EN 1253-2



Roof Terrace & Facade
 Kitchen
 Bathroom
 Entrance & Lobby
 Spa & Pool
 Basement
 Parking
 Garden & Landscaping

ACO GM-X Galvanized steel pipe system

Product overview

ACO GM-X pipes made of galvanized steel are successfully used in the field of flat roof drainage in the Nominal size of DN 32 - DN 300. The extensive range of pipes and fittings allows a fast and economical solution for each installation situation. Due to the proofed socket connection, a quick and easy plug-in installation by turning the pipe and fittings can be executed in the sleeve. The production of the ACO GM-X pipe system complies to all requirements of EN 1123.



Wide range of nominal sizes

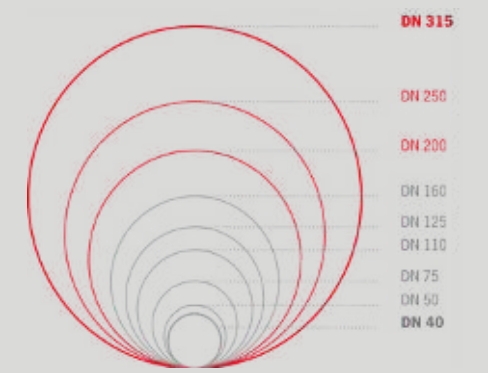

- Breakage protected
- Dimensionally stable
- Heat resistant up to 95 ° C
- Non- flammable (A1)
- Frostproof
- Outer sleeve provides enhanced functional security
- Additional internal sound protection coating
- Protection against condensation water prevents the formation of mould

Kitchen



Kitchen

Commercial kitchens are extremely busy environments with potentially wet and greasy floors due to the abundance of liquids used in both the cooking and cleaning processes, and of course, liquids are often very hot!

Waste water can also contain fat which could cause a major problem of pipe blockages and cannot be released to the waste water system. In combination, these factors may affect Food Safety, Operational cost and Health & Safety.

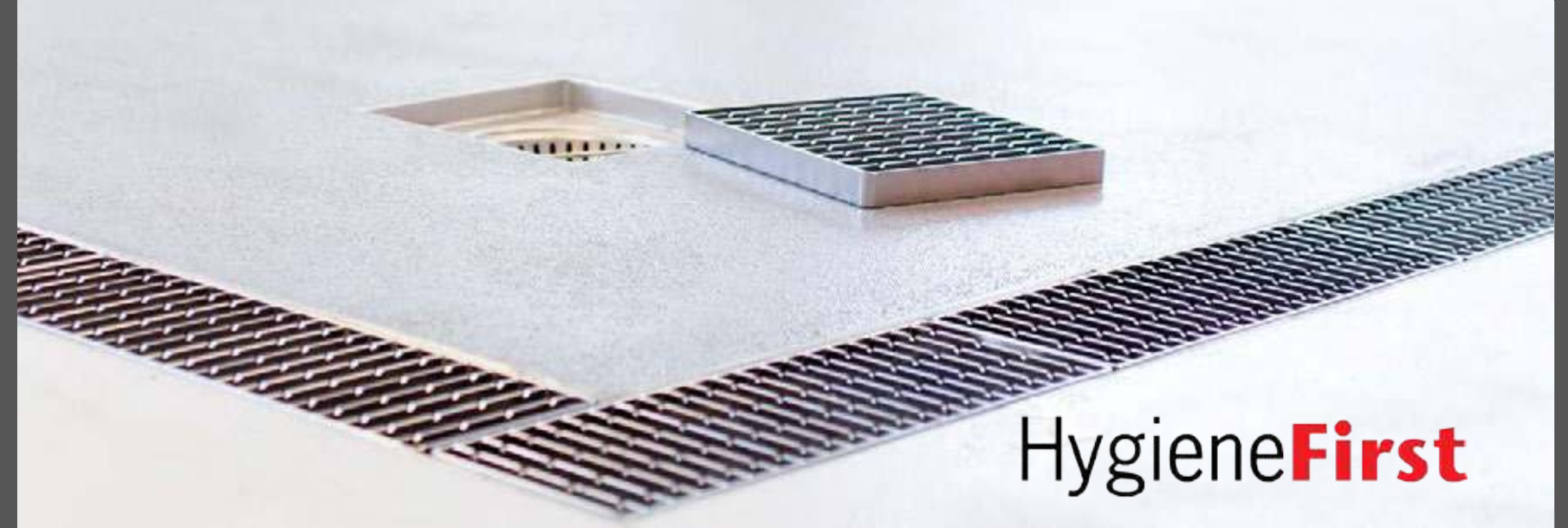

Food safety

Food safety can be severely affected due to poor drainage and grease separation systems. ACO solutions are designed to effectively and safely drain away and handle process water. We design our products specifically to reduce the risk of food contamination.

Cost control

Management of costs is a major factor in business today. Commercial kitchen equipment including drainage and grease separation systems should fulfil its function with low operational cost in mind throughout its entire lifespan. ACO drainage and grease separation systems are designed so they can be easily maintained, reducing associated cleaning costs and maximising hygienic performance.

Health & safety

Minimizing the risk of injury in the workplace is of prime importance to any commercial kitchen facility. It's essential that your facility has a drainage system which improves health and safety conditions during cleaning, emptying and operation, while ensuring hygiene is always front of mind.

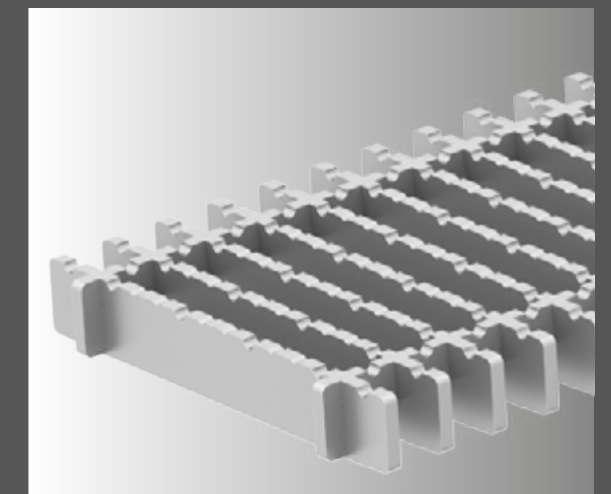
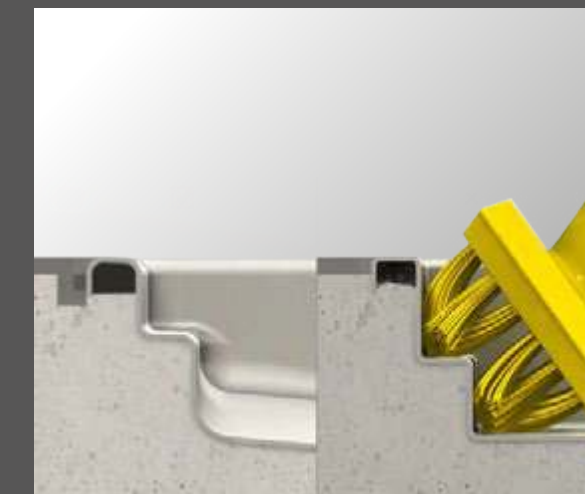

European norms and regulations

- **EN 1672** Food processing machinery-hygiene requirements
- **EN ISO 14159** Safety of machinery - Hygiene requirements for the design of machinery
- **EN 1253** Gullies for buildings. Gullies with light liquids closure

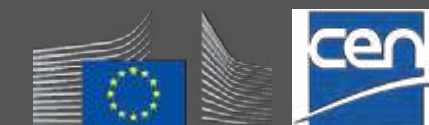



Innovative products and expert collaborations

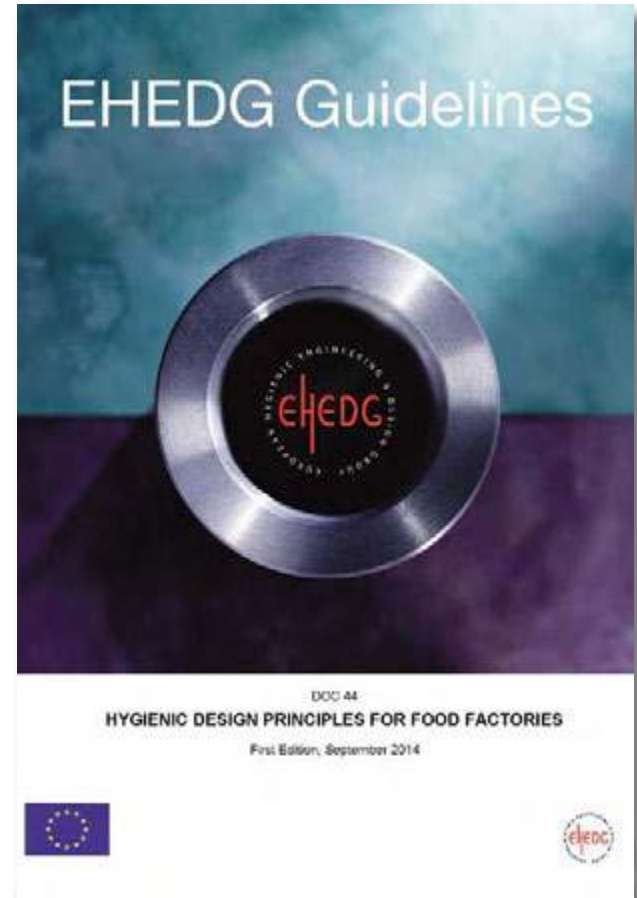

ACO works closely with leading industry suppliers and institutions to raise drainage performance standards. We also connect with, listen to and understand people that matter – be chefs, hygiene officers, engineers, kitchen planners, cleaning providers, contractors, researchers or business owners.

Our collaboration with experts helps us to understand the risks of poorly designed drainage, raise standards of product performance and enable specifications that empower the designer and end user to achieve the best possible outcome.

In addition to providing high performance drainage products, we also offer a comprehensive range of services to support you through the life of your project and, via our in-house technical design team, can develop engineered solutions which are tailored to meet specific requirements.

With its advanced drainage solutions for commercial kitchens and the food industry

ACO cares about hygiene and food safety. That's why ACO is a long term member of the European Hygienic Engineering and Design Group, EHEDG. Both, ACO and EHEDG, have recently decided to extend their cooperation for the year 2015.

ACO and flooring specialist Sika commissioned a three year study and research program to provide factory and processing operators with clear evidence-based guidance with regard to flooring-drainage connections. The results of the research led to the development of a customised L-profile edge solution. It is resistant to both thermal and dynamic shocks and is being incorporated into our product design.

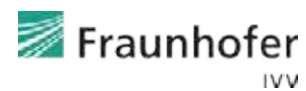

ACO System solutions for kitchen



Hygienic Drainage



Pipes



Wall protection



Grease Separators



Wastewater Lifting Plants



ACO Hygienic Box Channel

Product overview

The ACO hygienic box channel range incorporates hygienic principles to ensure the optimum hygienic performance. The hygienic box channel range is ideal for applications where high standards of hygiene are required as they are capable of handling large volumes of fluid. ACO hygienic box channels are certified according to EN 1253.

- Hygienic design following EN 1672, EN ISO 14159 and EHEDG document 8, 13 and 44
- V-shape bottom for width up to 300 mm, reinforced bottom for width above and including 400 mm
- Adjustable EasyFix levelling feet
- Fully pickled and passivated
- Wide range of gratings for load classes L15, M125 and R 50

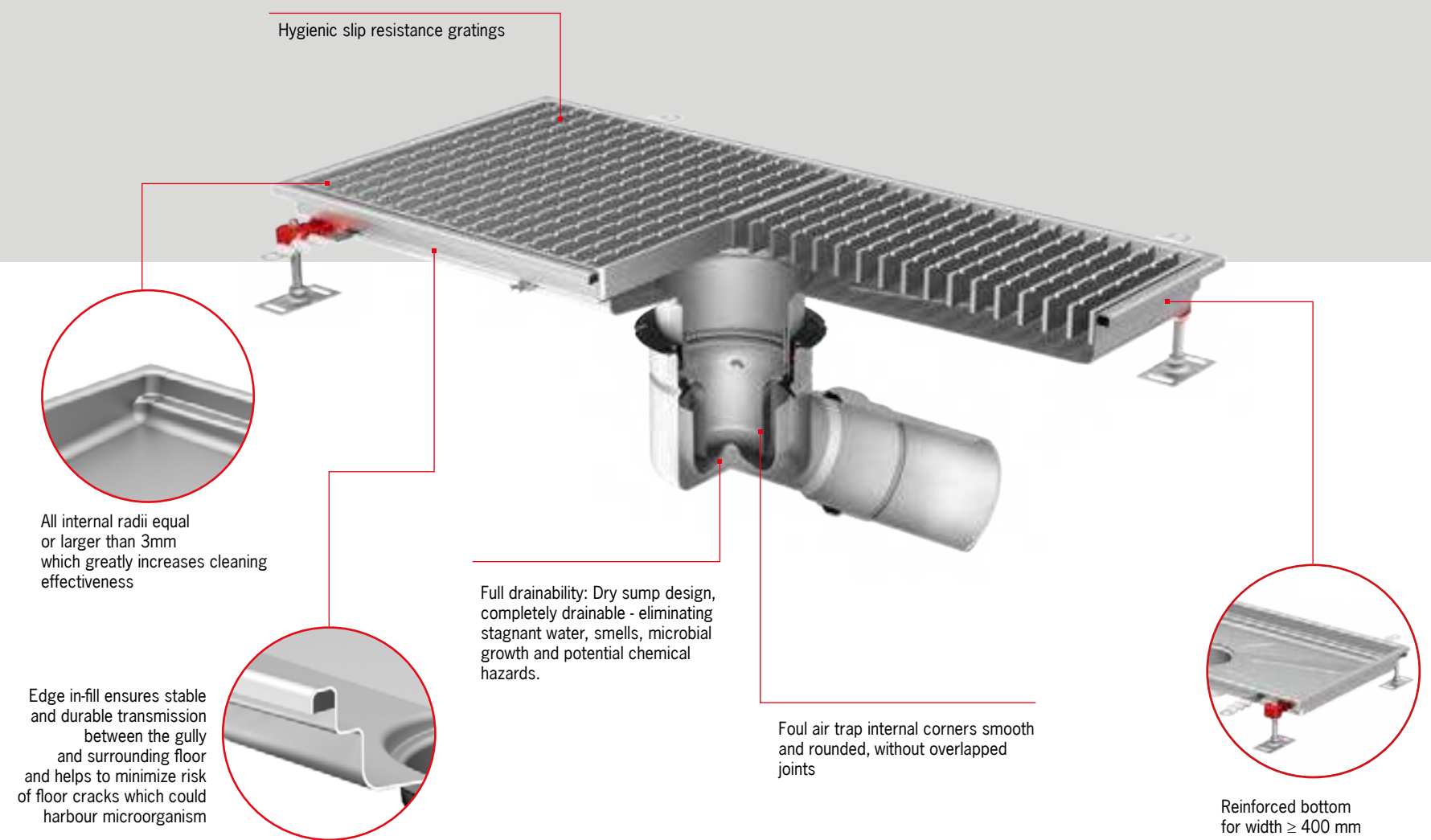



Roof Terrace & Facade
 Kitchen
 Bathroom
 Entrance & Lobby
 Spa & Pool
 Basement
 Parking
 Garden&Landscaping

ACO Hygienic Gully

Product overview

The ACO hygienic gully range incorporates the hygienic design principles to ensure the best hygienic performance. Available in three body sizes, this range caters for various flow rates and construction requirements including shallow construction depths. Fire protective solution is also available for applications where preventative measures are required. ACO hygienic gully is tested and certified according to EN 1253-1 and EN 14159-1.

- Full drainability
- Internal radii equal or larger than 3 mm
- Hygienic joints
- Edge infill
- Stainless steel grade min. 1.4301 according to EN 10088 (304 according to AISI)
- Fully pickled and passivated



Gratings for ACO hygienic gully

A variety of grating types is available depending on application and requested load class. For applications with high hygienic demands ladder grating frameless or slot cover should be selected.

- Hygienic design following EN 1672, EN ISO 14159 and EHEDG document No. 8, 13 and 44
- Available in 1.4301 (304) or 1.4404 (316L) grades of stainless steel
- Fully pickled and passivated
- Certified according to EN 1253-1
- Range of gratings suitable to load class L 15, R 50, M 125 or N 250 (EN 1253-1)
- Slip resistant solution available



Roof Terrace & Facade
 Kitchen
 Bathroom
 Entrance & Lobby
 Spa & Pool
 Basement
 Parking
 Garden & Landscaping

ACO Pipe

Stainless steel pipe system

Product overview

The stainless steel push-fit pipe system is designed for grey or black water. ACO pipe offers 40+ years product life thanks to its material properties. Easy installation and handling on site is ensured by push-fit assembly system and available cutting tools. ACO pipe is more hygienic, robust and durable when compared to plastic.

Wide range of nominal sizes



Six advantages of ACO pipe

<p>1</p> <p>Resistant to thermal expansion</p>	<p>2</p> <p>Sagging proof</p>	<p>3</p> <p>Class A1 fire resistant</p>
<p>4</p> <p>Rodent proof</p>	<p>5</p> <p>Durable</p>	<p>6</p> <p>Lightweight</p>

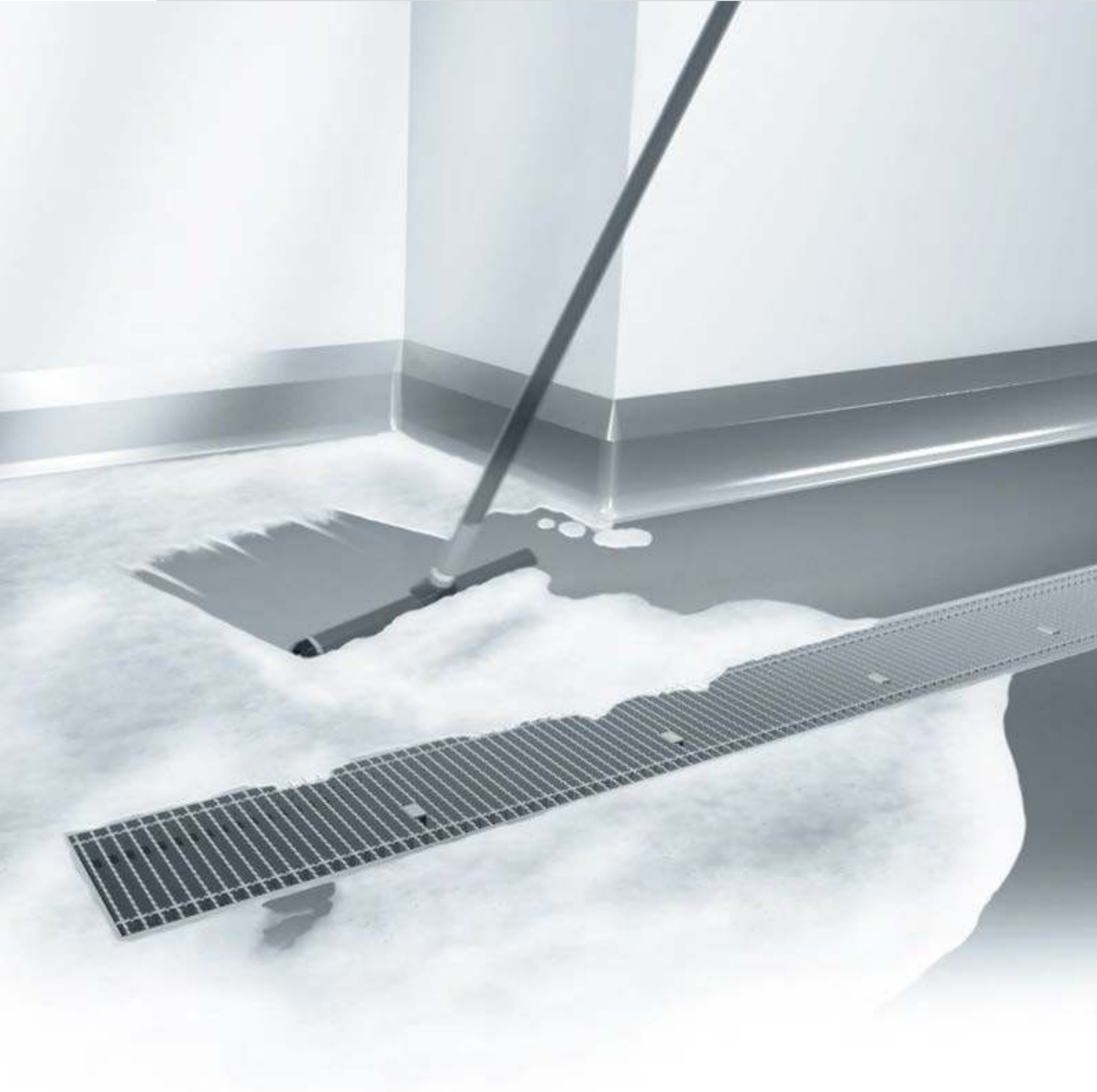

Roof Terrace & Facade
 Kitchen
 Bathroom
 Entrance & Lobby
 Spa & Pool
 Basement
 Parking
 Garden&Landscaping

ACO Kerb

Hygienic wall protection

Product overview

ACO kerb is a reliable wall protection system that prevents walls from impacts (200 mm height up to 1 ton, 300 mm height up to 5 tons as recommended by EHEDG), water or chemical ingress, or other damages associated with traffic and production process. It is suitable for any food processing area.

- Protects walls from impacts caused by machinery or other transport systems
- Eliminates water ingress into the wall and leakage into other processing areas
- Curved design prevents accumulation of soils and allows easy cleaning



ACO kerb PB



ACO kerb PB-plain



ACO kerb S/S - single side



ACO kerb S/S - double side





ACO Lipurat/ Hydrojet Grease separators

Product overview

ACO Grease separators according to European Standard (EN) 1825 rely on the relative density naturally present in the influent. FOGs, whilst wide ranging in relative density, are always less dense than water and naturally float on the surface of the water within the separator unit. Similarly, solid particulates common to most cooking processes are denser than water and sink to the separator base.



ACO Lipurat-OAE (stainless steel)

- Grease separator plant as per DIN EN 1825 and DIN 4040-100
- For indoors installation – frost free
- With integrated sludge trap
- Draining connection, fire hose quick coupling B 2½"
- Suction and emptying sump with drain plug socket 1½"
- Automatic high-pressure internal cleaning with pump
- Nominal pressure: 175 bar
- Capacity: 13 l/min
- Chopping, mixing, rinsing in one process
- Disposal pump with free flow impeller
- Motor power: 3.0 kW/2850 rpm



ACO Hydrojet-Jet-OSE (PE-HD)

- Grease separator plant as per DIN EN 1825 and DIN 4040-100
- For indoors installation – frost free
- With integrated sludge trap
- Operating side: right/left
- Draining connection, fire hose quick coupling B 2½"
- Suction and emptying sump with drain plug socket 1"
- Manual operation of the high pressure internal cleaning with pump
- Nominal pressure: 175 bar
- Capacity: 13 l/min]
- Disposal pump with free flow impeller
- Motor power: 3.0 kW/2850 rpm



ACO Grease trap AGT-40

- Designed for below-sink use in commercial kitchens and other foodservice establishments
- Prevents grease and food debris from entering waste water
- Protects waste water from grease and food debris
- Biological activators degrade and consume the FOG aiding the prevention of blockages in the wastewater system



Roof Terrace & Facade
 Kitchen
 Bathroom
 Entrance & Lobby
 Spa & Pool
 Basement
 Parking
 Garden&Landscaping

ACO Multi

Wastewater lifting plants

Product overview

Apart from the installation site and delivery head, the quality of the wastewater is another important aspect for choosing the right lifting plant. Wastewater from washing machines or washbasins, so-called grey water (non-faecal wastewater), does not contain any bulky solids. It can therefore be transported more easily than black water. Lifting plants for black waste water are designed to easily transport solids with-out blocking.



ACO Multi-Star DDP wastewater lifting plant for faecal wastewater – for freestanding installation

- Low weight
- Different inlet heights
- CFD-optimised impeller
- Ready to connect
- High usable volume – up to 185 l
- Adapted to door dimension: 780 mm

Suitable for:

- Grey and black water
- Use downstream of grease separators up to NS 15



ACO Multi Pro-PE K duo wastewater lifting plant for faecal wastewater – for freestanding installation

- Different inlet heights
- High operational safety due to pneumatic pipe and air bubble injection
- Energy saving channel impeller pump
- Adapted to door dimension: 780 mm
- Wastewater lifting plants

Suitable for:

- Grey and black water
- Use downstream of grease separators up to NS 20

Bathroom



Bathroom

Designing a high quality bathroom involves a combination of aesthetic and functional challenges. The bathroom area is the place in the hotel where the requirements for comfort, safety and design are crucial for the overall wellbeing experience. The trends in modern bathroom interiors are providing space and freedom of movement. Architects need flexible solutions that provide uncompromising quality, safety and freedom of design.



Barrier-free design

The idea of the floor-level bathroom design is inspired by generous space trends by reducing materials and transitions into renouncing all optical and factual barriers. It is also required in any public spaces where freedom of movement and free access for people with disabilities, elders or young children must be supported.

Quality

High quality of materials in bathroom designs is essential not only for the durability of the interior, but also for creating harmony between the different surfaces and ensuring safety and easy maintenance of the area. Special focus must be placed on reliable connection between all elements of the surface to ensure complete water tightness and prevention of damage to the structure or hygiene risks.

Care

Easy and effective maintenance is essential both for the guest experience and operational costs. This is especially important in bathroom areas. Round shapes and flat surfaces without disturbing components provide for both a harmonious design as well as for easy cleaning. In addition, all surfaces need to be particularly resistant to detergents.

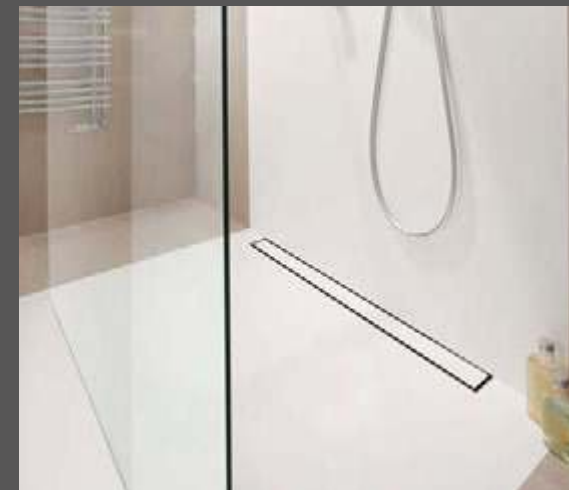

European norms and regulations

• EN 1253 - Gullies for buildings

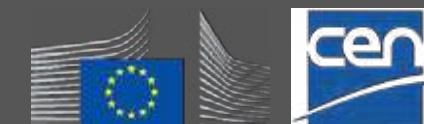



Design & function provided by state of the art production technology



Many years of international experience in providing solutions for hotels, bathrooms and sanitary areas have given us deep knowledge and understanding of the essential requirements, needs and challenges that those projects meet. We support our partners and customers with high quality materials, perfect workmanship and outstanding design capabilities.

The comfort of a safe and easy installation is essential. Our one-piece solutions are ready to install completely watertight. Together with detailed illustrated manuals the installation is efficiently managed.

Some areas of application have special architectural specifications and therefore require customized solutions, measured precisely down to the millimeter. Our flexible production facilities provide endless possibilities for customized designs and individual solutions.

Our portfolio includes a wide choice of aesthetic stainless steel solutions to fit to every interior style. The electro-polished finishing supports design and easy cleaning due to ultra-smoothed surfaces.

ACO's premium products for hotel bathrooms guarantee maximum safety, load resistance and hygiene while meeting the highest design expectations.

As a future orientated company ACO is investing into environmentally friendly product solutions. Recuperation of energy is only one example towards sustainable buildings.



The heat exchanging drainage for shower areas offers a cost-saving and environmental solution.



ACO System solutions for bathroom



ACO ShowerDrain E+



ACO ShowerDrain C



ACO ShowerDrain S



ACO Bath Gully MG



Roof Terrace & Facade
 Kitchen
 Bathroom
 Entrance & Lobby
 Spa & Pool
 Basement
 Parking
 Garden & Landscaping

ACO ShowerDrain E+ Stainless steel line drainage

Product overview

ACO ShowerDrain offers the perfect way to create generously sized, uniform bathroom designs without any interruptions, changes in materials or barriers. Whether the design incorporates discreet lines, curved point drainage areas, designer gratings made from stainless steel or glass covers, a hotel logo or integrated LED modules – with this option, the possibilities are endless. What is more, ACO's premium products for hotel bathrooms guarantee maximum safety, load resistance and hygiene.



reddot design award



- Material: Stainless steel, material grade 304
- Load class: Meets K3 requirements
- Internal channel width: 80 mm
- Flow rate: 0.6 l/s (with 20 mm build-up as per EN 1253-1)
- Outlet socket: Suitable for all push-fit pipe socket systems
- Foul air trap: 2-part, removable
- Flange types: Surrounding wall flanges
- Channel: Electropolished surface
- Mounting: Ready for installation
- Sound protection: Sound protection accessories integrated as standard
- Total building height: 105 mm (with water trap 50 mm)

ACO ShowerDrain E+
 with vertical flange



ACO ShowerDrain E+
 with horizontal flange



Accessories



Hair strainer

- For retrofitting and minimum reduction of the shower channel's flow value by 0.04 l/s



ACO EasyStop

- Prevents drying out of the water trap in the foul air trap
- Material: plastic with membrane insert and lip seal

Your individual hotel design/
 logo

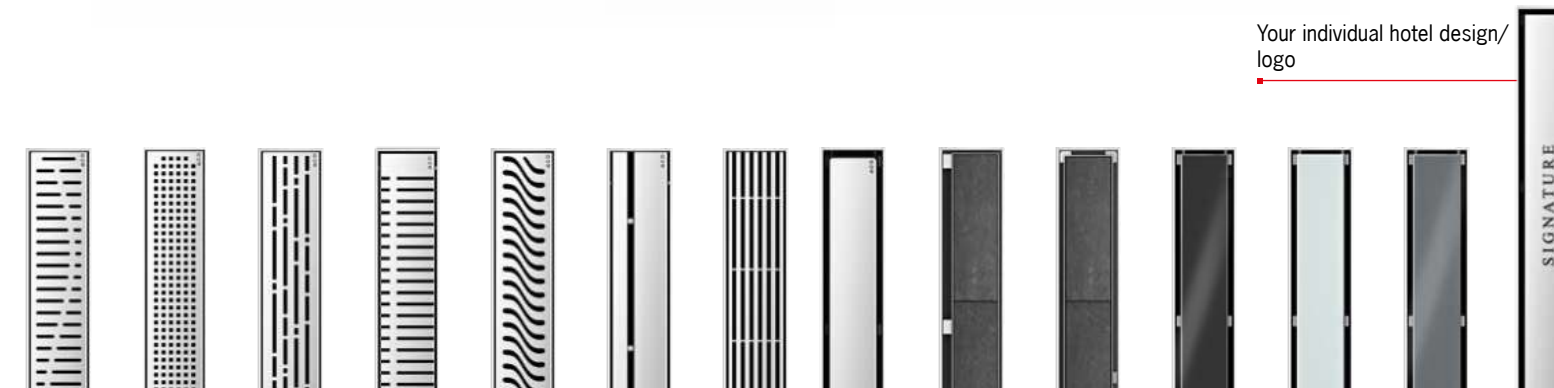



Roof Terrace & Facade
 Kitchen
Bathroom
 Entrance & Lobby
 Spa & Pool
 Basement
 Parking
 Garden&Landscaping

ACO ShowerDrain C

Stainless steel line drainage

Product overview

ACO ShowerDrain C offers a minimum building height of 65mm to unfinished floor level. Due to the removable foul air trap the full access to the pipeline is provided helping for the optimum cleaning of the channel. Furthermore the welded stainless steel body minimizes the risk of leakage and in the same time provides high flow rate of the system.



- Material: Stainless steel, material grade 304
- Load class: K3
- Internal channel width: 64 mm
- Flow rate: 0.9 l/s (with 20 mm build-up as per EN 1253-1)
- Outlet socket: Suitable for all push-fit pipe socket systems
- Flange design: Permanently cast-on, for optimum connection of a compound seal
- Type of flange: Surrounding
- Mounting: Ready for installation
- Channel body: Pickle passivated
- Gratings: Grinded
- Grating variants: Stainless steel designer gratings, tileable cover

ACO ShowerDrain C
with vertical flange



ACO ShowerDrain C
with horizontal flange



ACO ShowerDrain C
without flange

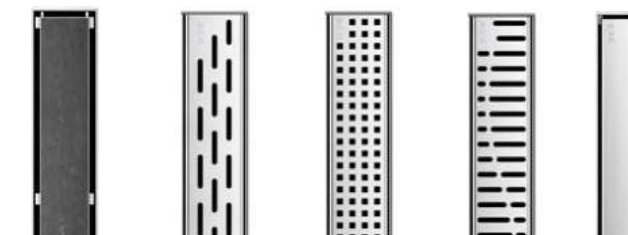



Roof Terrace & Facade
 Kitchen
 Bathroom
 Entrance & Lobby
 Spa & Pool
 Basement
 Parking
 Garden&Landscaping

ACO ShowerDrain S

Stainless steel line drainage

Product overview

ACO ShowerDrain S offers a minimum building height of just 55 mm to unfinished floor level and meets all sound protection requirements (SSst I-III in acc. with VDI 4100). The removable submersible pipe in the foul air trap and the e-polished surface ensures the optimum maintenance. With just 2 cm visible width ACO ShowerDrain S is a perfect choice for elegant and discreet look offering comfortable barrier-free movement around the shower area.



- Material: Stainless steel, material grade 304
- Load class: K3
- Internal channel width: 34 mm
- Flow rate:
 - 0.5 l/s without build-up (ND 50/ND 40)
 - 0.8 l/s with 20 mm build-up (ND 50 as per EN 1253-1)
 - 0.65 l/s with 20 mm build-up (ND 40 as per EN 1253-1)
 - 0.35 l/s without build-up (ND 32)
 - 0.55 l/s with 20 mm build-up (ND 32 as per EN 1253-1)
- Outlet socket: Suitable for all push-fit pipe socket systems
- Flange design: Permanently cast-on, coated at the factory, for optimum connection of a compound seal

ACO Shower Drain S
Gully ND 32



ACO Shower Drain S
Gully ND 40



ACO Shower Drain S
Gully ND 50



Accessories



Hair strainer

- Prevent pipes becoming obstructed with hair
- Simple removal and cleaning
- For retrofitting
- Minimal reduction in shower channel drainage of 0.04 l/s

Stripes

Plate

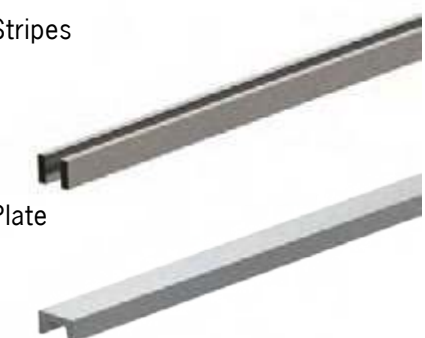



Roof Terrace & Facade
 Kitchen
Bathroom
 Entrance & Lobby
 Spa & Pool
 Basement
 Parking
 Garden&Landscaping

ACO Bath gully

Point drainage

Product overview

ACO Easyflow floor gullies range offers wide choice of solutions for bathroom drainage. The gullies can be used either as main drainage system or in combination with line drainage. The variety of design gratings offers stylish combinations with line drainage solutions, as well a completely discreet option with integrated tile in the fully frame.

The products are in full compliance with EN 1253-1 and all functional requirements. The installation is compatible with different floor structures and tile thickness. Easy maintenance is provided after full removal of the foul air trap.



ACO Easy flow

- Material: Plastic, Top section ABS Gully body PP
- Outlet socket: Suitable for all push-fit pipe socket systems
- Flow rates: 1.0 to 1.6 l/s
- Gully body flange type: Clamping flange
- Mounting: Ready for installation
- Grating variants:
 - Stainless steel (round or square)
 - Tileable, Glass
- Retrofittable upgrades:
 - Fire protection
 - Lighting option
 - Dry foul air trap



ACO Bath Gully MG

- Grating: 95 x 95/ 104 x140
- Water trap: 25 mm
- Inclination: 1,5°
- Installation height: 51 mm



*Explore more grating desing on page 78



ACO Supplementary components

Product overview



ACO ShowerStep



ACO Lightline Pro



- Three heights (10, 12,5 and 15 mm) for different tile thicknesses
- Two lengths available
- Pre-formed gradients
- Easy to fit
- Material: Stainless steel, material grade 304
- Upper surface: 12 mm, for use with or without glass shower wall



- Prefabricated stainless steel profile with cast
- LED lighting
- Scatter coating to create the appearance of a light strip
- Suitable for barefoot and wet areas
- Protection class IP 68

Entrance & Lobby

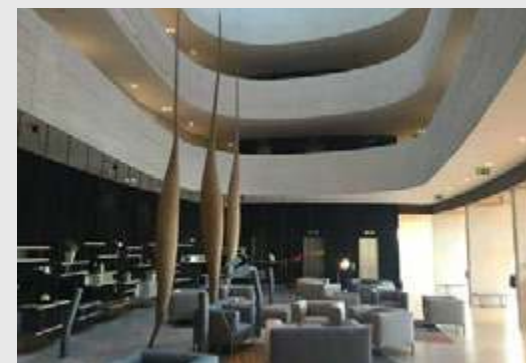

Entrance & Lobby

There's only one chance to make a great first impression. The entrance of the hotel is an introduction to the complete guest experience. It is usually the busiest area of the building, where aesthetics and easy maintenance are crucial. Systems that support the easy maintenance and trouble-free hotel routines should be integrated in the area without interrupting the design concept of the lobby.



Aesthetics

Each detail in the lobby area can be the business card for the hotel. It may be a luxurious hotel with a spacious entrance or a cozy family hotel – it is this area that first welcomes the guests. Therefore, the complete interior design with all integrated elements should be in harmony with the style and identity of the hotel. Special focus should be put on the surface to allow barrier-free and unobtrusive movement.

Maintenance

Operational cost of the hotel can be significantly optimized if maintenance is taken into consideration during the design phase. The busy area at the hotel entrance requires easy and effective cleaning with correct design of designated areas that limit dirt and dust entering the building from the outside. Easy access to utility systems is needed without disturbing the visual appearance.

Durability

Maintenance and renovation works affect the operations in the hotel and particularly the entrance is a sensitive spot that cannot be easily closed or exchanged. All systems and materials in the interior area have to provide long-lasting functionality and a visually pleasing appearance. Therefore, special attention needs to be paid to high-quality materials and careful selection of elements.



European norms and regulations



- **EN1253** - Gullies for buildings.
- **EN1433** - Drainage channels for vehicular and pedestrian areas.





Freedom of design and tailor made solutions



-  Zone 1 - Coarse dirt
-  Zone 2 - Fine dirt and moisture
-  Zone 3 - Remaining fine dirt and moisture



Our years of working side-by-side with architects, investors and facility managers help us see the hotel project through their eyes and easily recognize the most important issues that need to be addressed during the planning phase. To meet the needs of each different project we provide freedom of design and delivery tailor made solutions that fit the specific requirements. In order to keep the interior floors and surfaces beautiful, clean and free of obstacles for free movement, the area needs to be carefully planned.

Designing designated areas to keep dirt from the outside and fine dust entering the inside of the building can optimize cleaning costs up to 90%. It is recommended to have 3 segments of the shoe scrapers – exterior part for bigger dirt particles, a segment within the spinning door and interior part for fine dust. The features of the doormat system are calculated by the expected number of people entering the building. Our offer includes a variety of professional shoe

scrapers that meet all requirements for design, traffic and load resistance, size and shape. The doormats are framed to the floor which prevents unnecessary movement and slipping and at the same time providing an even surface for smooth movements. In addition to that the high quality stainless steel profile of the shoe scraper can be personalized with the hotel brand or navigation text.

Complex communication and utility services within the hotel building often require access points for maintenance and revision to be placed in floor boxes or under the surface. As final component of those points the access cover can be easily integrated into the overall design concept of any sophisticated or individual building objects. Due to the selectable covering, installed in the lid of the cover – the solution is an ideal adaptation to the existing flooring available. Our range of access covers offers a wide choice of materials, solutions for different load classes and application requirements.



ACO System solutions for Entrance & Lobby



ACO Mats



ACO Uniface cover



Roof Terrace & Facade
 Kitchen
 Bathroom
 Entrance & Lobby
 Spa & Pool
 Basement
 Parking
 Garden&Landscaping

ACO Mats

Entrance matting systems

Product overview

ACO offer aesthetically pleasing solutions in many functional variations. They will keep your entrance clean by eliminating dust and fine dirt and protect your expensive flooring. The shoe scraper mats are framed to stop them slipping and are installed flush with the floor surface, so level access to the entrance area is easy to achieve. ACO shoe scraper systems are available in individual dimensions to meet the requirements of a huge range of installation situations.

- System of solutions for all three zones of application
- Flawless functionality
- Freedom of design in shapes and layouts
- Customized appearance
- Variety of sizes and profiles for different traffic intensity
- Sophisticated details, including high quality stainless steel profile that can be customized with you hotel brand or navigation text or integrated LED lights





Roof Terrace & Facade
 Kitchen
 Bathroom
 Entrance & Lobby
 Spa & Pool
 Basement
 Parking
 Garden&Landscaping

ACO Uniface cover

Indoor access covers

Product overview

Hotels buildings need to meet special design expectations and often set a new standard for aesthetics and visual appearance. Surfaces are often design highlights. ACO Access covers provide freedom for planners without practical limitations. Recessed access covers are suitable for a thin floor surfaces in thickness up to 15 mm. The cover must be filled-up with concrete of required quality (C35/45) in order to achieve declared load capacity.

ACO Access Covers can be flexibly installed into any interior or exterior areas. Their installation and handling, as well as their maintenance and cleaning, are easy.

A wide range of standard types with many options, tailor made production and the possibility of using various floor surfaces make an ACO Access Cover look like an inconspicuous chameleon smartly merging into its background while retaining its full functionality and safety.

- Excellent optic aesthetics
- Meets declared load class up to M125
- Corrosion resistant alloy
- Precision thanks to crimping (mechanical fixing)
- 2+1 sealing – water/odour tight+sand/ dust tight
- Easy opening – prevents blockage
- Easy installation – positioning of the cover in frame
- Tiny tolerances, perfect fit
- Very small corner parts (30x30 mm)
- Brass nut to prevent blockage
- Reinforcement in optimal position

ACO Uniface Smart

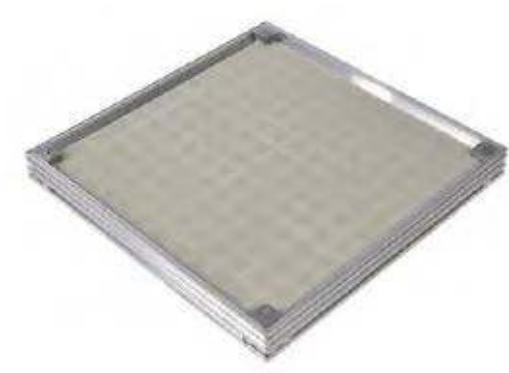

ACO Uniface Shallow



Spa & Pool



Spa & Pool

Spa and pool areas require special attention to every detail, usually being the signature area of the hotel building. As well as outstanding aesthetics and design that contributes to the feeling of wellness, particular focus must be devoted to safety and hygienic performance of the systems. Both outdoor and indoor areas are exposed to aggressive agents and/or weather conditions, therefore the materials used must be highly resistant and comply with strict safety requirements.



Safety

Safety is most certainly a major concern in public buildings and sensitive areas such as pools and spa areas have even higher demands. Minimizing the risk of injuries requires barrier-free movement, anti-slip surfaces, no sharp edges and special requirements in the areas where barefoot walking occurs. Easy cleaning and high flow rate to prevent blockage are important in terms of hygiene and maintenance costs.



Durability

In outdoor pools the drainage systems are exposed to weather conditions. For indoor pools a major point to be considered is the reliable sealing of the surfaces, as leakage of chlorinated water can cause major damage to the construction. In addition, cleaning and disinfectant agents used in pools, as well as salty water in case of seaside locations can impact the surfaces. Therefore high quality materials such as stainless steel or cast iron, or high quality composite materials should be considered.



Individual Design

Modern wellness areas feature sophisticated, generous space with barrier free surfaces. Floors covered with ceramic or natural stone are an integral part of the interior design. Surface slopes and transitions between different materials should be carefully planned. The drainage system could be discreet and unobtrusive or present a design feature. Projects often require versatile solutions in terms of design, size and customized shapes.



European norms and regulations

- **EN1253** - Gullies for buildings.
- **EN1433** - Drainage channels for vehicular and pedestrian areas.





*Technology and craftsmanship
are at the heart of our business*

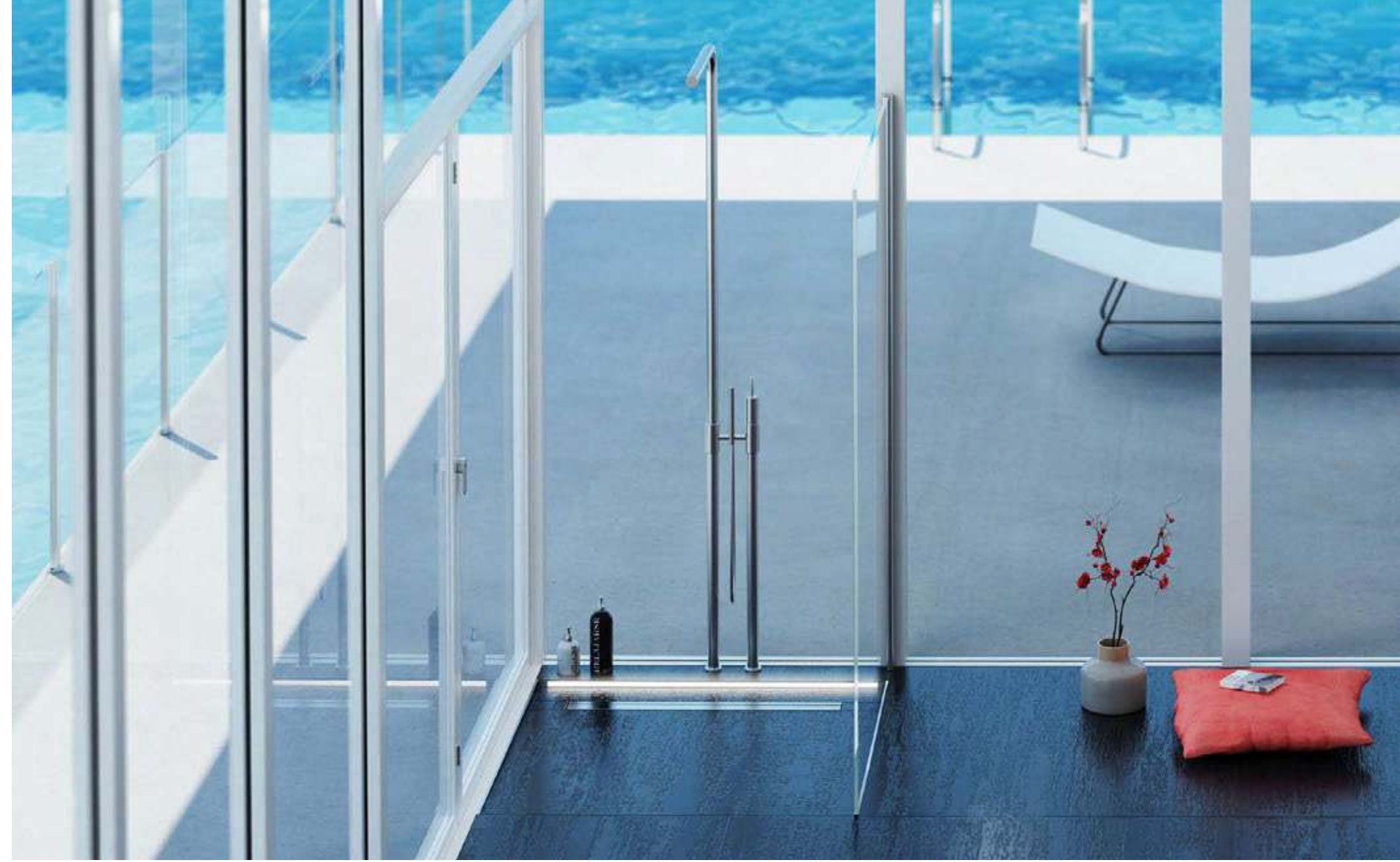

ACO employs extensive research and product innovation to stay at the cutting edge of drainage design and deliver "the future of drainage". Our aim is to understand how drainage acts in different environments so we minimize potential threats and optimize cleaning performance. We cooperate with world leading sanitation experts to improve our cleaning performance. All these activities give our R&D teams feedback about the latest trends and insights, and allow us to stay true to our commitment to delivering the ultimate drainage performance. All of our knowledge and expertise about hygiene and drainage integration is incorporated into product design, which comes to life in our production facilities.

With more than 40-years experience of stainless steel manufacturing, ACO continuously adopts new technologies and processes to ensure our products deliver the ultimate hygienic performance. ACO uses advanced technologies to ensure customers get the very highest quality products. As one of the world's leading stainless steel drain

producers we are well aware how an important role plays functional drainage of damp areas such as swimming pools, wellness or spa areas. In addition to the correct and functional drainage design, great emphasis is also placed on safety, protection against injuries, hygiene and last but not least individual design.

Therefore we offer several types of drainage depending on its location, functional requirements and design preferences of the investor or architect. We always work to find the best solution with regard to the functionality, safety of people and to optimize the cost of both acquisition and operating costs.

In order to meet all project requirements, construction, drainage is mostly made to measure. Technical consultancy in the design phase and during construction is an integrated part of our solution.



ACO System solutions for spa & pool



ACO Euroline



ACO Slot channel



**ACO ShowerDrain
Flex**



ACO Floor Gullies



Roof Terrace & Facade
 Kitchen
 Bathroom
 Entrance & Lobby
Spa & Pool
 Basement
 Parking
 Garden & Landscaping

ACO Euroline

Channels with gratings

Product overview

ACO Euroline channels offer the perfect solution for collecting water from pedestrian areas such as alleys, outdoor pools, playgrounds and gardens. The system offers a variety of designs to meet architectural requirements – such as stainless steel, cast iron or colored gratings. While providing safety and comfort for pedestrians, the gratings are also drivable. The system is easy to install and offers trouble-free maintenance.



- Polymer concrete or plastic channel body
- Variety of design gratings made of cast iron, stainless or galvanized steel
- Option for slot frame for discreet drainage
- Anti-slip and drivable



ACO Euroline



ACO Hexaline





Roof Terrace & Facade
 Kitchen
 Bathroom
 Entrance & Lobby
 Spa & Pool
 Basement
 Parking
 Garden & Landscaping

ACO Slot channel

Stainless steel slot drainage

Product overview

Thanks to its narrow profile, the 8mm slot channel is almost invisible at the floor. It is being installed mainly near swimming pools and in such environments, where unobtrusive drainage is required. The clear width of slot is only 8mm and the visible floor width with edges 14mm (folded edge) or 38mm (standard edge 15mm).

- Certified according to EN 1253 1 and EN 1433
- Available in 1.4301 (304) or 1.4404 (316L) grades of stainless steel
- Material thickness 1,5 mm
- Fully pickled and passivated
- Rubber edge infill for standard edge 15mm
- V-profile bottom for enhanced flow efficiency at low flow rates and for improved self-cleaning performance
- Adjustable EasyFix levelling feet
- Revision pieces 170x170mm for combination with ACO gullies EG150 (up to flowrate 1,5l/s) and ACO gully 142 (up to flowrate 1,9l/s)
- Gullies with horizontal or vertical outlet DN70 or DN100

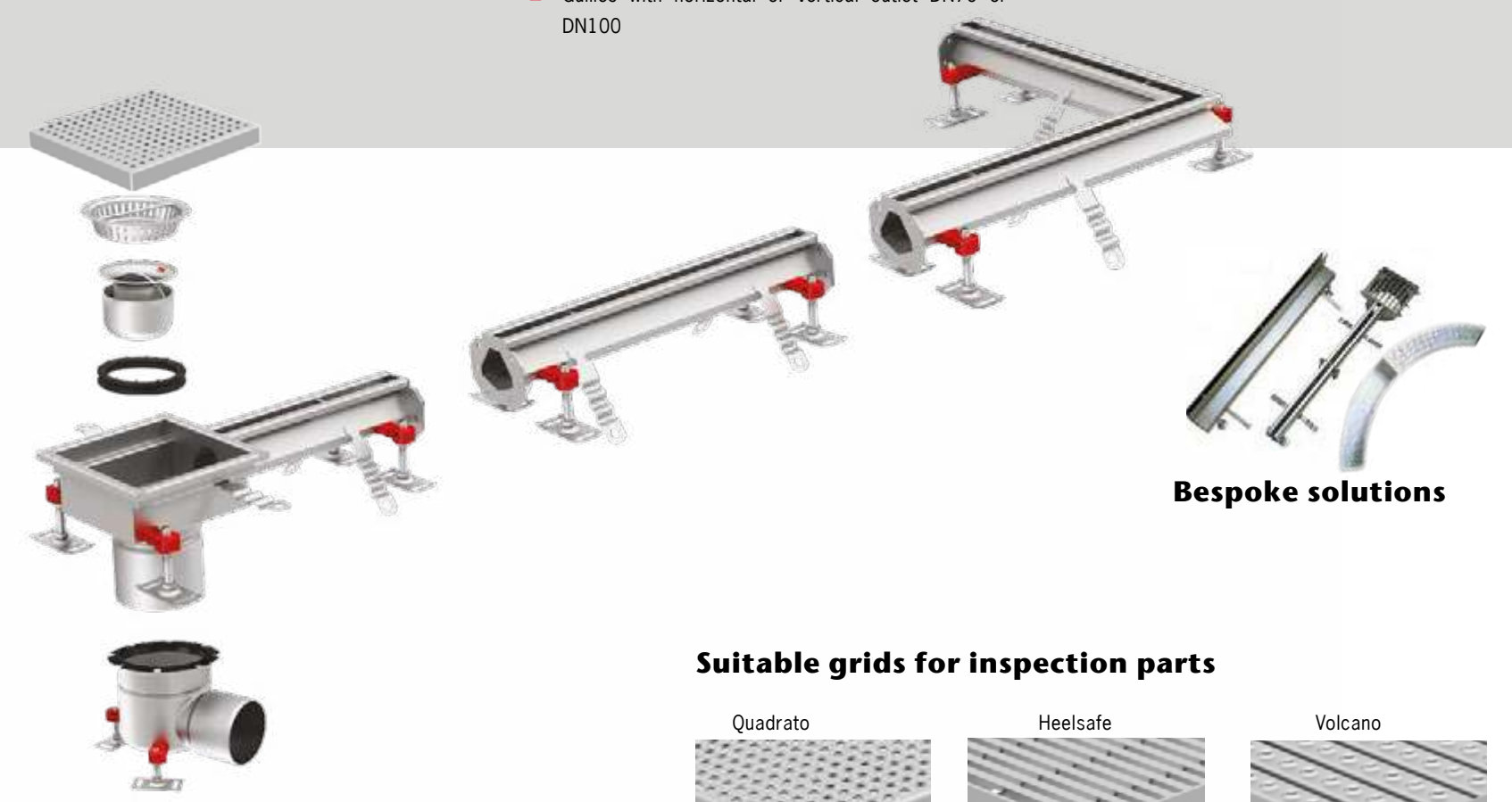

Bespoke solutions

Suitable grids for inspection parts





Roof Terrace & Facade
 Kitchen
 Bathroom
 Entrance & Lobby
 Spa & Pool
 Basement
 Parking
 Garden & Landscaping

ACO ShowerDrain Flex

Custom made line drainage

Product overview

ACO FlexDrain is a reliable and flexible solution for shared showers in pools and spa areas. The length of the channels can be ordered in compliance with the specific requirements. The internal longitudinal gradient of the bodies guarantees effective drainage. Stainless steel gratings in various designs offer aesthetic design, safety and easy cleaning.

- Width of single segment up to 6 m. Segments can be connected without visually disturbing the surface
- Typical production material is stainless steel grade 1.4404 (AISI 316) 1.4301 (AISI 304).
- Visible floor width 90 mm
- Horizontal flange for connection to thin-bed sealing
- Optional vertical flange for installation next to the wall
- Internal longitudinal slope of the body
- The shape and dimensions of the trough can be easily adapted to project requirements (corner joints, T-joints and angled joints).



ShowerDrain R70

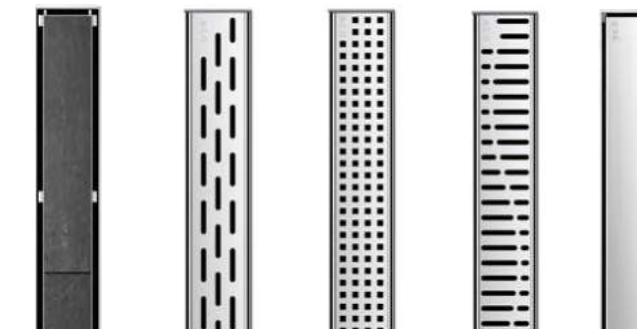

- Channel width excl. flange and upstands: 70mm
- Channel height incl. drain body and upstands: 85
- Welded drain body DN 50 horizontally
- Tile edges height: 12 mm, mounting feet L: 200 mm
- Material: stainless steel 1.4301



Roof & Terrace
 Kitchen
 Bathroom
 Entrance & Lobby
 Spa & Pool
 Basement
 Parking
 Garden & Landscaping

ACO Easyflow Floor gully

Product overview

ACO offers a wide range of floor gullies suitable for spa & pool applications. To meet the requirements of EN 1253-1 we recommend the installation of a ACO Easyflow floor gully. It has been designed for different floor thickness and floor structure heights and offers an optimum pipe access after removal of the foul air trap. ACO Easyflow floor gully is retrofittable thanks to an assembly-friendly fire protection kit. It is available for all gully bodies with vertical socket inclination in ND 50, 70 and 100.



- Material: Plastic, Top section ABS Gully body PP
- Outlet socket: Suitable for all push-fit pipe socket systems
- Flow rates: 1.0 to 1.6 l/s
- Gully body flange type: Clamping flange
- Mounting: Ready for installation
- Grating variants:
 - Stainless steel (round or square)
 - Tileable, Glass
- Retrofittable upgrades:
 - Fire protection
 - Lighting option
 - Dry foul air trap

ACO Easyflow



Designer gratings made from stainless steel



Basement



Basement

Modern and innovative systems give a whole new value to underground spaces of the building. Fresh air, natural light and protection against flood or moisture provide the opportunity to make use of the basement, not only as storage and facility rooms, but also a variety of other purposes. With increasingly extreme weather events, the main objective is protecting the construction, underground spaces and any equipment installed against flood.

Designing effective protection systems prevents potential material and financial damages which could also affect the functionality of the whole building.



Water tightness

Climate change causes increasingly extreme weather incidents. Heavy rainfalls more frequently and initiates significant damages to buildings and infrastructure. The challenge to protect the lower levels of the building from flood and moisture is of utmost importance. The objective is to protect the construction, the underground spaces and equipment and thus the safety and comfort of inhabitants.

Backflow control

In the case of heavy rainfall the public sewer may be overloaded, the water presses down into the basement. Backflow control ensures that the basement remains dry. The underground areas in particular can be affected quickly by backwater. This may result in damages to equipment and cause significant maintenance costs.

Natural light and fresh air

The lack of fresh air or natural light significantly limits the functionality of the underground level of the building. Especially in urban areas with dense construction, every square meter is valuable for the investor. Providing access for natural light and ventilation not only gives more opportunities for use of the basement but also reduces the operational cost of the building.

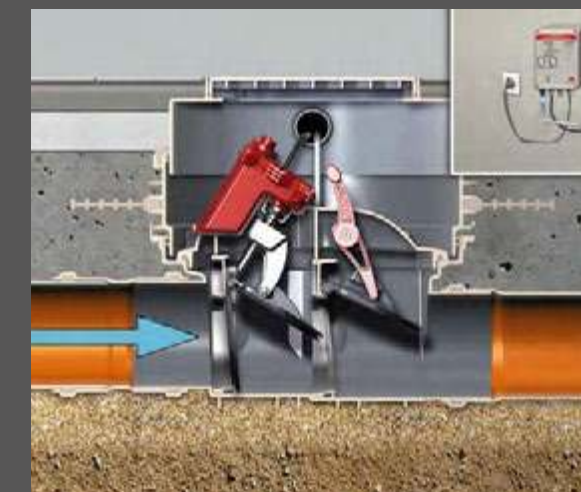

European norms and regulations

- EN 13564 - Anti-flood devices for buildings
- EN 14351 - Windows and doors. Product standard, performance characteristics. Windows and external pedestrian doorsets





Smart solutions for a whole new purpose of underground spaces



Modern architecture trends clearly put high requirements for functionality of basement spaces. Real estate prices and return of investment rates imply that each square meter of the building should be used as effectively as possible. With the complexity of hotel projects, there are a variety of facilities situated in the basement levels - eg. a fitness centre, spa area, staff offices or house-keeping equipment.

Irrespective of the use designated to the below ground area, there are a number of factors that can guarantee safe and cost-effective operation within the areas and protect the building as well as equipment and ensure constant operation of the facilities.

The most important prerequisite is reliable anti-flood protection. Climate change requires pioneering innovations to counteract extreme weather conditions. That includes systems that guarantee ultimate water tightness, back-flow prevention and energy saving.

In addition, ACO's innovative solutions for basement areas can give a whole new purpose to the underground spaces. Designing a system that allows natural light and fresh air into the room can make it comfortably inhabitable for a range of purposes.

In addition to the innovative system solutions, ACO work side by side with architects and planners and to support reliable designs with extensive knowledge on trends, regulations and contemporary requirements, professional consulting, calculation software and statutory documentation.



ACO System solutions for basement



ACO Therm Lightshaft



ACO Therm Cellar window



ACO Therm Block



ACO Backflow systems



Roof Terrace & Facade
 Kitchen
 Bathroom
 Entrance & Lobby
 Spa & Pool
 Basement
 Parking
 Garden&Landscaping

ACO Therm Lightshaft

Product overview

The ACO Therm light shafts are highly rigid and can be used not only for standard areas but also for pressurized water. They can be adapted to the existing level of the ground or floor with the help of stacking components. ACO offers reliable protection for your basement and its contents. The ACO Therm basement protection system, which comprises the ACO Therm Block with an integrated window that is proof against flooding, together with the ACO Therm light shaft that is mounted so that it resists pressurized water, with the ACO light shaft drainage and ACO backflow protection, ensure the rooms in the basement are dry, warm and lit naturally.

Awards for the design profile grating:

- Plus X Award**
 - Best product 2016/2017
 - High quality, design and functionality
- Iconic Award 2016**
 - Winner category products facades



Grating: walkable and drivable

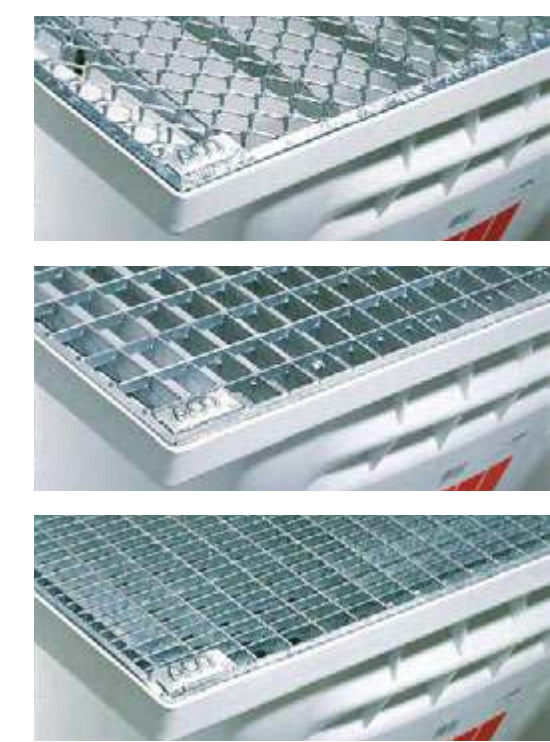

ACO Therm Lightshaft with backflow stop
 The ACO Therm light shaft is additionally secured thanks to the backflow stop. The integrated valve ensures that backflow is not pushed into the light shaft and thus can not get into the basement.



ACO Therm Cellar Window

Product overview

For new building construction, the ACO Therm® system consists of windows, which are based on current and future insulation standards. All ACO Therm® 3.0 windows - whether standard or passive house version - contains a 4-chamber plastic wing and a 5-chamber plastic frame with a profile depth of 82 mm.

Mainly for flood-prone areas, a flood-proof version of the ACO Therm® 3.0 reveal window is available.

The high-waterproof ACO Therm® 3.0 is also burglar-resistant to class RC2.

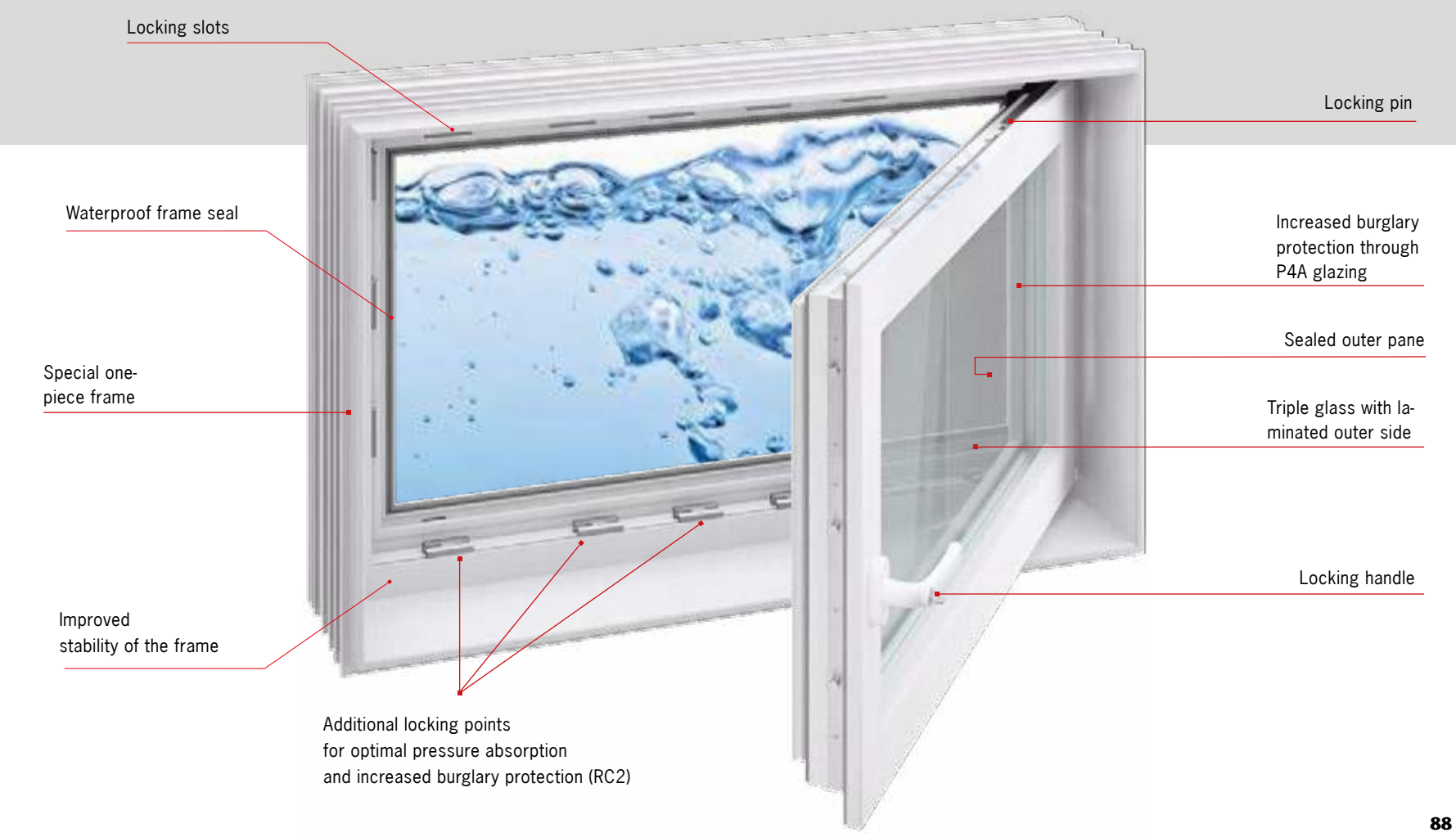



ACO Therm Block

Product overview

ACO Therm System provides integrated solution for basements. The innovative ACO Therm Block provides heat-insulation, waterproofing, and flood protection in one system. It is compatible with standard lightshafts and integrated waterproofing. Additional benefit of the system is the quick and simplified installation, preventing the need of additional finishing.



- The high quality PUR-material guarantees easy installation, watertight system and reliable heat-insulation
- Sealing flange for watertight connection
- Easy installation without need of additional finish
- Integrated system with ACO Therm Lightshafts and Cellar windows

ACO Therm Block range



Standard panel with integrated window frame

Standard panel with integrated therm-window

Panel with integrated waterproofing and window frame

Panel with integrated waterproofing and therm-window



Roof Terrace & Facade
 Kitchen
 Bathroom
 Entrance & Lobby
 Spa & Pool
 Basement
 Parking
 Garden & Landscaping

ACO Triplex & Quatrix-K Backflow preventers

Product overview

Active backflow safety valve units are also differentiated according to the type of wastewater: either wastewater containing faeces or wastewater free of faeces. A large number of lifting plants, submersible pumps and pump stations are available for this purpose. Active backflow safety valves are used wherever there is no natural gradient towards the sewer.



Backflow safety valve Triplex for water without faecal matter

- Made of plastic
- Type 2 tested to EN 13564
- For non-faecal wastewater (grey water) and rainwater harvesting systems
- With two automatically closing backflow flaps, one of which as a manually lockable emergency valve
- With large cleaning and maintenance opening and test hopper



Quatrix-K – for exposed pipework

- For installation in exposed pipes
- Type 3F tested to EN 13564
- With double backflow safety valve
- With 1 automatic operating seal
- With 1 manual emergency valve
- With large cleaning and maintenance opening and test pipe
- With ready to plug in, electrical control unit IP 54 with integrated 4-week self-monitoring
- With visual and acoustic backflow signal

Parking



Parking

Parking areas are an integral part of any hotel or public building and a crucial factor for the overall functionality of the building, including daily operations of the staff and visitor's comfort. Whether the parking area is open and therefore exposed to different weather conditions, underground area or multi-story parking decks, where construction heights and other building systems need to be observed – our comprehensive range and dedicated design support will provide you with the optimal solution.



Effective drainage

The impermeable surface of public parking areas creates a significant volume of surface water runoff that needs to be addressed. Underground parking spaces often require drainage solutions with restricted installation space and special attention in the area of the access ramps, where slopes and intensive traffic imply special requirements to the drainage system.

Aesthetics

Drainage systems are integral part of landscaping in public parking areas. Therefore, their finish and design are required to complement and enhance the aesthetic qualities of the property. Modern surface water management solutions are designed to provide further architectural and aesthetic value to the project with variety of design options, discrete slot openings and integrated LED lights.

Surface water treatment

At any site, such as car parks, where there is risk of surface water being contaminated by hydrocarbons are required steps to prevent pollution. Sustainable drainage systems require control of surface water runoff and, as part of this approach, oil separators treat water before being discharged.



European norms and regulations

- EN 1433 - Drainage channels for vehicular and pedestrian areas
- EN 858:2003 - Separator systems for light liquids
- EN 124 - Gully tops and manhole tops for vehicular and pedestrian areas
- EN 13564:2003 - Anti-flooding devices for buildings
- EN1253 - Gullies for buildings





Complete surface water treatment solutions for indoor or outdoor parking



As the world leader in surface water management and water protection, ACO offers a comprehensive range of line drainage solutions. Whether the parking area of your hotel is external, underground or you have a parking deck you can freely choose between a variety of products, designs and materials.

ACO Drain® range offers a variety of channels with design gratings, slotted or monolithic channels as well as kerbs with integrated drainage.

In the design of components and structural elements, the choice of suitable materials determine the aesthetic and functional qualities of the product. The materials used by ACO are characterized by their strength, ageing resistance and their resistance to aggressive media, frost, heat and sunlight. Thanks to their long life and recyclability, they are equally sustainable and environmentally compatible and are used in an application-orientated way.

Surface water that runs in parking areas contain significantly more contamination than most

people are aware of. Traffic areas are contaminated with harmful materials from tyres (abraded material), brake dust and exhaust gases and traces of petrol and oil. Therefore it is essential that the collected water is treated and cleaned before discharged into the sewage systems or in nature. ACO offers a complete system solution for surface water management, including oil and heavy metal separators, retention and infiltration systems to fit your project requirements.

Surface water management of underground or indoor parking can often be a complex task. The limited installation space in parking decks is a major challenge for drainage systems. At the same time, a special focus is required to providing watertight connection between the channel, the slab and the pipe system. The ACO Design Team is able to work closely with you through the entire design process. Our unique Hydraulic design software enables the efficient and accurate hydraulic design of surface water management schemes using channels as means of conveyance.



ACO System solutions for parking



ACO MultiDrain Seal in



ACO KerbDrain



ACO Qmax



ACO Monoblock



ACO Deckline



ACO Oil separators



Roof Terrace & Facade
 Kitchen
 Bathroom
 Entrance & Lobby
 Spa & Pool
 Basement
 Parking
 Garden & Landscaping

ACO MultiDrain Seal in

Drainage channels with design gratings

Product overview

The ACO MultiDrain range is designed to provide advantages for all – from the design phase to the installation and maintenance. The Seal in technology consists of the waterproof, frost-resistant polymer concrete channel body and a standard integrated 2-component EPDM seal on the gutter joint. It offers a variety of load class options, sizes, edge rails and the widest choice of standard, design or customized gratings. In addition to all that you can benefit from professional design tools to visualize the surface design and calculate the optimal drainage performance.



reddot design award



DESIGN AWARD 2015



German Design Award

NOMINEE 2015



- Choice of design gratings: Cast iron, stainless steel, galvanized steel or plastic
- Freedom to create individual designs, as well as option for integrated LED lights
- Polymer concrete channel for optimal stability, hydraulic performance and resistance
- Flexible design options, due to variety of sizes, including low-profile solution

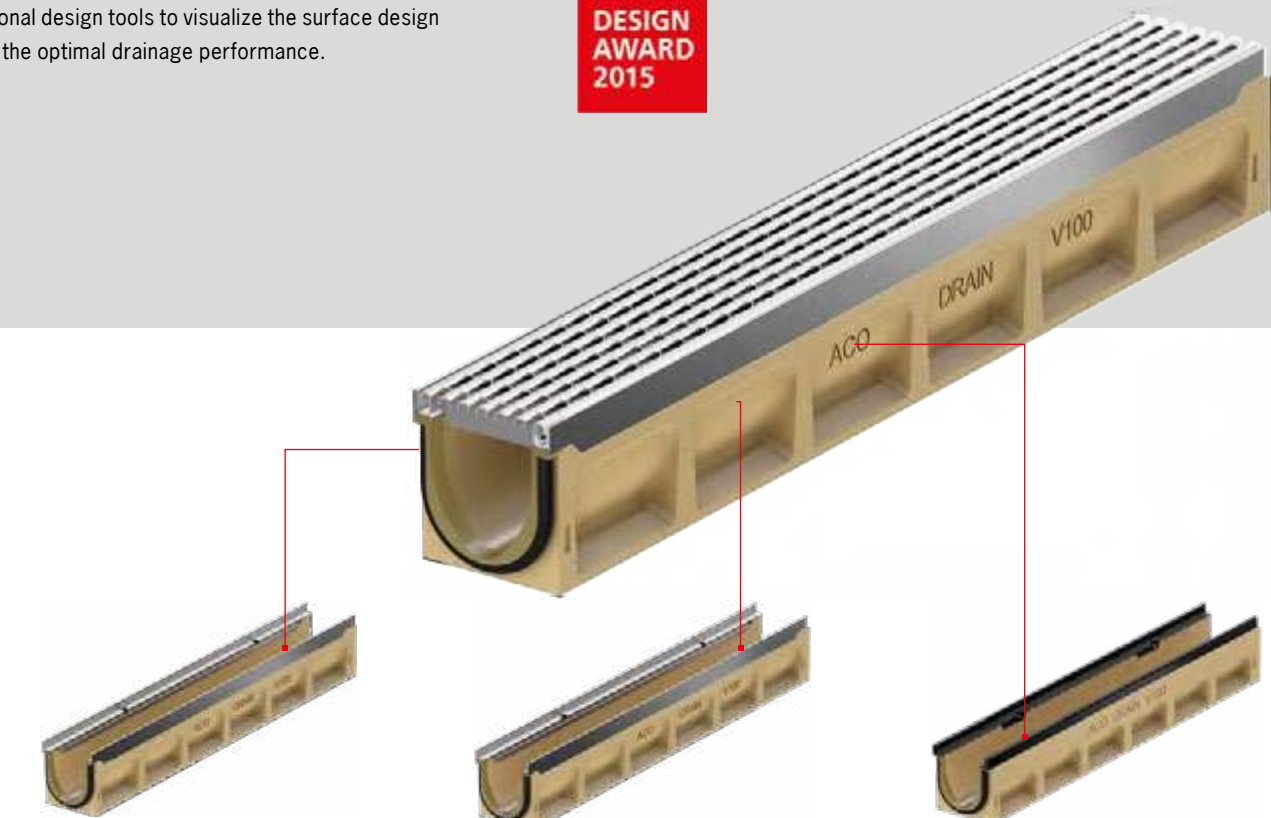

Frame: steel, galvanised

Frame: stainless steel

Frame: Cast iron

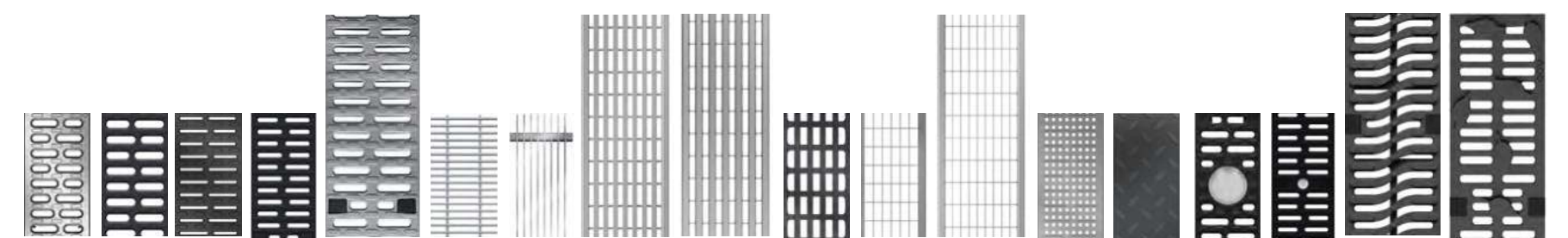



Roof Terrace & Facade
 Kitchen
 Bathroom
 Entrance & Lobby
 Spa & Pool
 Basement
 Parking
 Garden & Landscaping

ACO KerbDrain

Kerbs with integrated drainage

Product overview

ACO KerbDrain is an award winning combined kerb and drainage system specifically designed and developed to form an integral part of any modern, sustainable surface water management solution. The system provides versatile solutions for traffic and parking spaces, curves and access areas. It guarantees optimal lateral drainage while leaving the surface uninterrupted.



- Combination of surface drainage and curbstone: "2 in 1"
- Monolithic system with no loose parts
- Manufactured from polymer concrete for optimal stability and resistance
- Variety of elements for form curves and access areas

Choice of depths
 Available in 255mm,
 280mm, 305mm,
 380mm, 405mm and
 480mm depths

Drainage inlets
 designed to
 resist debris
 blockage

50% higher impact
 resistance than
 traditional kerbs

DF hole for draining porous
 asphalt or providing temporary
 drainage of subsurface during
 installation

Sealant groove for
 simple watertight
 installations

Load Class D 400
 ACO KerbDrain® is fully
 certified to Load Class D 400
 EN 1433:2002 and CE marked

Installation benefits
 Kerb units available in
 1000mm and 500mm
 lengths

Made from
 sustainable materials
 Thermally stable,
 chemically resistant,
 environmentally friendly
 polymer concrete.



External surfaces
 anchor channel securely
 into concrete surround
 to prevent displacement

Suitable for
 highway drainage in
 compliance with EN
 1433:2002



Roof Terrace & Facade
 Kitchen
 Bathroom
 Entrance & Lobby
 Spa & Pool
 Basement
 Parking
 Garden & Landscaping

ACO Qmax® High capacity slot drainage system

Product overview

ACO Qmax® satisfies the demand for a versatile, high capacity slot drainage system for applications involving small to large catchment areas. It is specifically designed to form an integral part of any modern, sustainable surface water management solution. The system maximizes the hydraulic capacity available providing effective storage, attenuation, and eliminating carry over in stormwater conditions.



- Hydraulic capacity slot channels
- All advantages of slot and heavy duty channels in one system
- Highest hydraulic capacity and attenuation
- Variety of sizes and edge rails to suit your project requirements



One piece design provides minimal connection joints and simple installation

Ultra stiff rib design provides high strength during handling and installation

Levelling feet for ease of installation and stability

Channels can be cut at pre-determined lengths to suit application

Manufactured using recycled material 

Integrated channel seal for quick and easy watertight connections*

Lightweight material and design for easy manual handling and fast installation



Q-guard cast iron edge rail



Q-flow galvanized steel edge rail



Q-flow cast iron edge rail



Q-guard galvanized steel edge rail



Q-slot galvanized steel edge rail



Roof Terrace & Facade
 Kitchen
 Bathroom
 Entrance & Lobby
 Spa & Pool
 Basement
 Parking
 Garden & Landscaping

ACO Monoblock

Monolithic drainage channels

Product overview

ACO Monoblock is a one-piece channel drainage system that delivers multiple benefits including safety and sustainability, economical and efficient installation and aesthetic choices across various applications. Designed to meet extreme requirements, such as intensive traffic and weather conditions, the system provides also optimal comfort for pedestrians and easy maintenance.

- Monolithic structure for superior stability even in extreme conditions
- No loose parts, traffic and vandalism safe
- Suitable both for pedestrian and traffic zones
- Colour options to suite aesthetic requirements

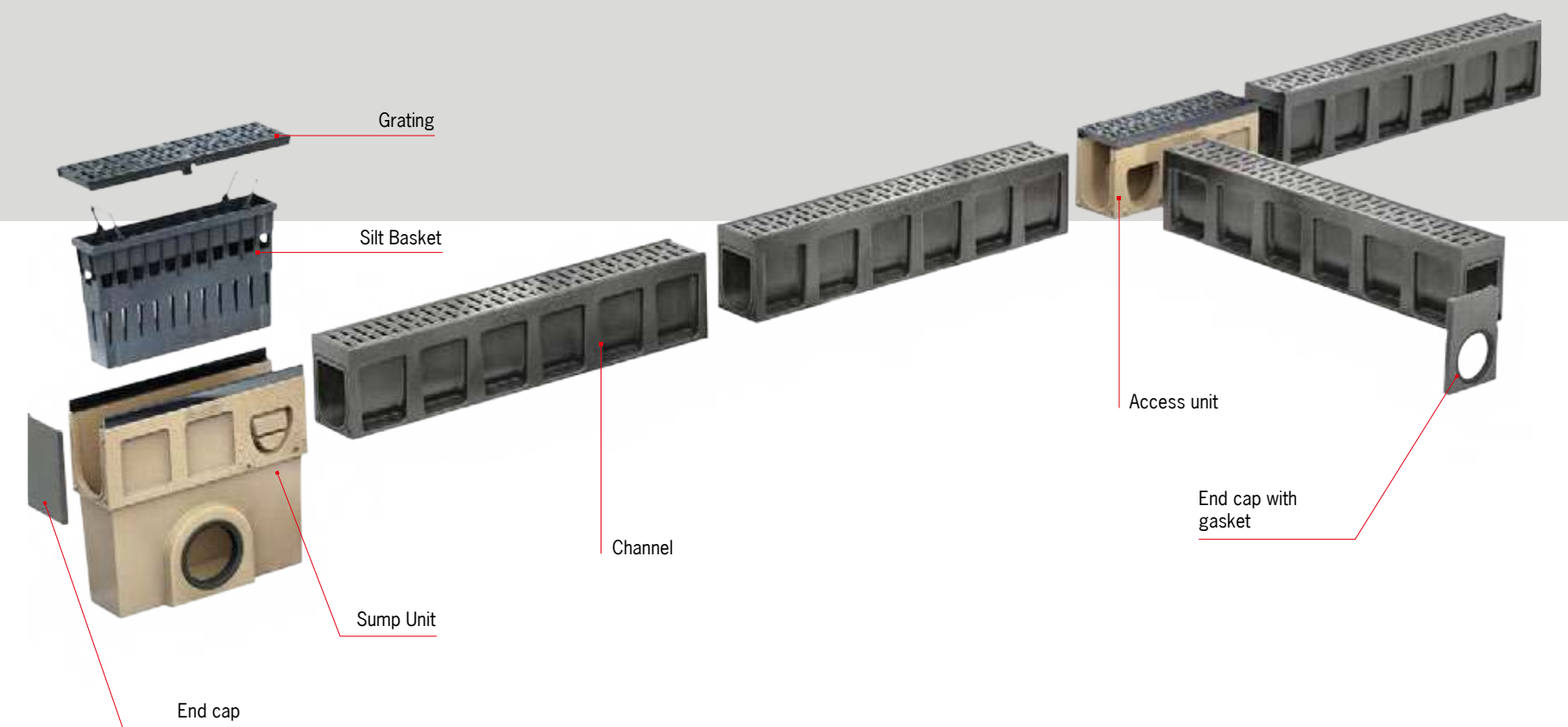

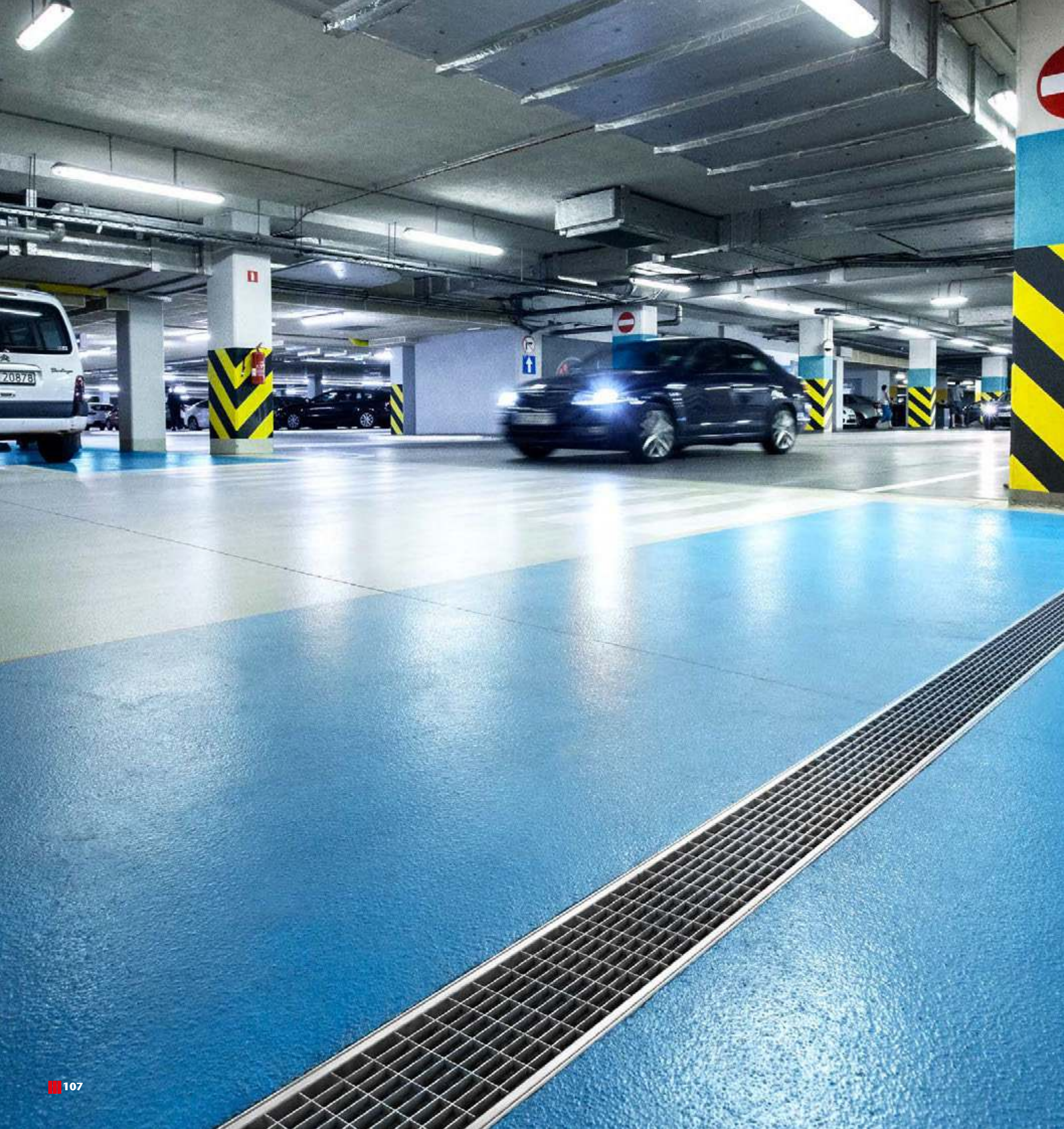

ACO Deckline

Line drainage for parking decks

Product overview

ACO Deckline channels are made from only highly resistant materials such as polymer concrete or stainless steel. Suitable gratings are made from composite plastics, stainless steel or cast iron. For a lengthy lifetime of building and drainage channels, ACO strongly recommends to use exclusively run-off drainage systems in combination with grated channels for easy maintenance and cleaning in parking facilities.

ACO Deckline S without coating-flange

ACO Deckline S with coating-flange

ACO Deckline P



- Compatible with penetration element to connect sealing layer underneath the channels.
- Watertight connection system with 3M sealing tape. No welding. No screwing.
- Quick and easy installation process through simple connector system. Optional "hanging" installation.
- Material: Stainless steel V2A.
- High load class performance up to C250.
- Flexible: Recommended solution for concrete or screed flooring. Others equally possible.

- Integrated flange for firm and durable connection with resin coating layers.
- Watertight connection system with 3M sealing tape. No welding. No screwing.
- Quick and easy installation process through simple connector system.
- Material: Stainless steel V2A.
- High load class performance up to C250.
- Recommended solution for resin coated surfaces. Others equally possible.

- Designed for asphalt surface, others equally possible
- Watertight connection system with 3M sealing tape. No welding. No screwing.
- Material: Polymer concrete
- Installation - Quick and easy
- High load class performance up to C250.
- Robust type-I tested channel in three colour options (natural, grey, anthracite).



ACO Oil Separators

Surface water treatment for light liquids

When do light liquid separators have to be used?

The use of light liquid separators is stipulated by the regulations in DIN 1986-100, Section 6.2.3: "If petroleum or light oils, especially those that are combustible or can form explosive atmospheres, enter the sewers, separator systems for light oils must be used downstream of the discharge points." Discharging petroleum and light oils into public sewers can cause groundwater and drinking water contamination, and in serious cases, cause extensive environmental damage to flora and fauna. The solution to this problem is a light oil separator. Any light oil in the wastewater is collected in a separator tank and prevented from being discharged from the separator. The discharge outlet closes automatically when the maximum storage capacity has been reached. The light oil which collects in the separator is disposed of by certified recycling companies at regular intervals.

ACO Coalisator P

- for free standing installation according to EN 858
- certificate 7310434-01 (NS 3-10)
- inlet and outlet connection according to outside diameter D depending on nominal size of separator
- inlet and outlet parts of polyethylene
- with integrated removable coalescing filter
- automatic closure device with float switch, density of float switch: 0.9 g/cm³



ACO Oleopator P

- for ground installed installation according to EN 858
- certificate 7310434-01 (NS 3-10)
- inlet and outlet connection according to outside diameter D depending on nominal size of separator
- inlet and outlet parts of polyethylene
- with integrated removable coalescing filter
- automatic closure device with float switch, density of float switch: 0.9 g/cm³



Garden & Landscaping



Garden & Landscaping

Design of green areas and pedestrian zones is an integral part of modern architecture and is crucial not only for the aesthetic appearance of the project but also for the comfort and wellbeing of the inhabitants.

As the meeting point between architecture and nature – landscaping faces the challenges of providing at the same time sustainable protection of the environment and, protection and design of the surface, comfort and safety.



Surface sealing

Urban sprawl and the construction of paved areas mean less and less natural ground drainage. This can mean bigger and more expensive water treatment systems to deal with the water flowing into sewers. A sustainable solution is to ensure the large-scale seepage of rainwater back into the ground. Modern regulations are counteracting the sealing of surfaces by stipulating building restrictions and regulations limiting surface sealing.



Functional requirements

Designing a garden, park or promenade is about balancing between creative and constructive challenges of contemporary landscape architecture. On one hand it is important to design a surface which is comfortable and safe for pedestrians or an occurring traffic. On the other – it is vital for the plants in the area to be provided with the right environment and protected from damaging impact.



Aesthetics appearance

Green areas represent an absolutely vital part of our existence. Their integrating into construction projects is significant for our comfort and well-being. Modern landscaping systems are protecting natural environment and at the same time creating visually pleasing designs in correspondence with architectural surfaces.



European norms and regulations

- **EN 1433** - Drainage channels for vehicular and pedestrian areas
- **EN 124** - Gully tops and manhole tops for vehicular and pedestrian areas
- **EN 752** - Drain and sewer systems outside buildings





Solutions for the interface between architecture and nature



ACO's range of garden and landscaping systems help architects and landscape planners to create an attractive and sustainable water management solution which provides optimal functionality of the surface and comfort for visitors.

Tailored to the demands of the specific projects our products have finish options that complement and enhance the aesthetic qualities of any property. The modern and functional range provides the most complete and stylish surface water management offering for driveways, pedestrian and landscaped areas. The range has been manufactured to the highest quality standards, ensuring long life and service within and around your hotel landscape.

Besides a comprehensive range of drainage solutions, the range includes a variety of products that allow planners to comply with modern regulations and trends for sustainable design and preserving natural surfaces that allow water infiltration back to the ground.

ACO's ground stabilization systems are ideal for use in driveways and paths, where a natural grass or decorative gravel finish are required to complement the landscape, whilst also reducing the risk of potholes, rutting or grass damage and at the same time provide solid and even surface which is drivable and suitable for pedestrians.

The ACO Stormbrixx infiltration systems provide even further advantages. It is an optimal solution for projects where sewer system is missing or limited, providing options for retention or infiltration of rain water. Its high void ratio reduces the cost associated with traditional soak ways and enables compliance with current building regulations concerning rainwater runoff and sealed surfaces. The range is completed by high-quality access and manhole covers, as well as cast iron tree protection systems.



ACO System solutions for garden & landscaping



ACO Grass&Gravel Grid



ACO Stormbrixx SD



ACO Tree Grills



ACO Manhole Covers

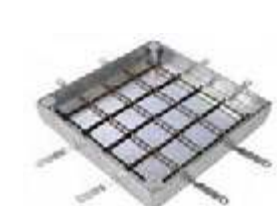

ACO Uniface covers



ACO Gully



ACO Grass Grid- pro nature

Ground stabilisations system

Product overview

Green areas are vital for environmental protection. The unnecessary sealing of areas exposed to minor traffic destroys valuable green space. ACO Grass Grid is made from plastic, and ensures free rainwater seepage in parking lots, yard driveways, terraces, walkways, storage spaces, emergency routes and river bank reinforcements. These areas will remain green, yet are still load-bearing. Through the use of recycled materials, ACO promotes environmental protection. Surface drainage systems such as ACO Self® or ACO DRAIN® can be used when sealed surfaces are required to aid area drainage. ACO Grass Grid is lightweight for easy transport and handling, and simply snaps together for fast installation. While regionally varying, many building regulations specify a certain amount of "green" spaces. ACO Grass Grid allows vehicular use of these areas.

- Offers unimpeded flow to surface water
- Manufactured from 100% green recycled polyethylene.
- Product design ensures easy handling and installation
- Tiles interlock with clip-together fixings
- Coverage: 4.42 tiles per square metre
- Tiles can be easily cut to shape for irregular edging
- Strong, robust system certified to 250 tones per square metre

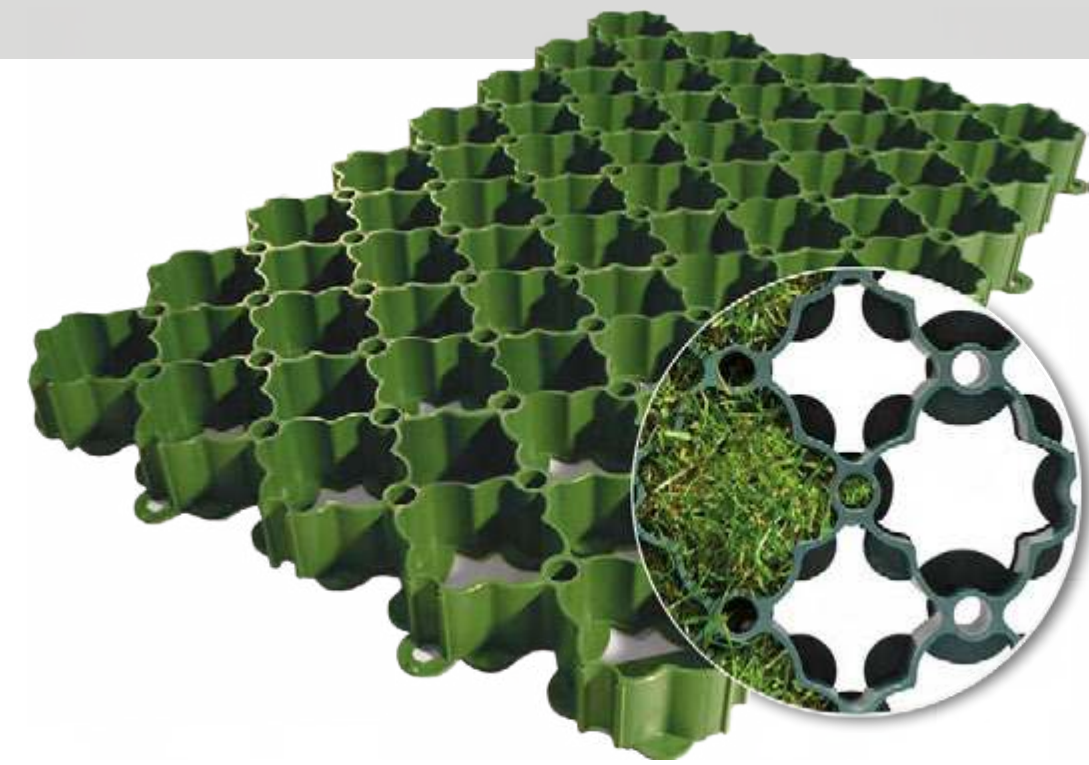
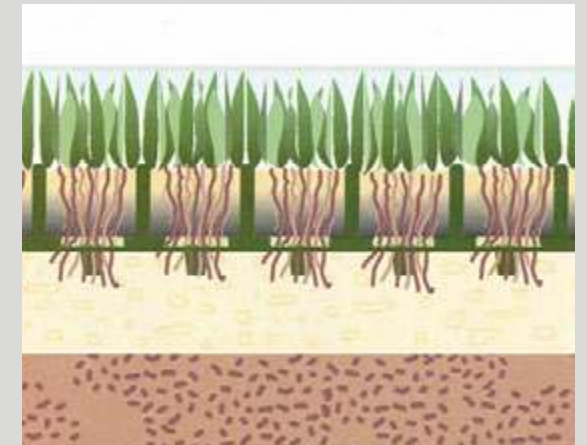



ACO Gravel Grid pro

Ground stabilisations system

Product overview

The honeycomb structure of the gravel stabilisation ensures that stones stay where they belong. They can no longer move left or right. This maintains a smooth surface with no ridges, troughs or holes. The ACO Gravel Stabilisation can be filled with high-grade chippings or ornamental gravel to create a customised surface.

Laying a water-permeable geotextile beneath the gravel stabilisation improves drainage of the surface. This saves having to pay municipal surface drainage fees for sealed surfaces, and prevents the formation of puddles.

Laying is very fast and easy because the honeycomb mats are laid loose next to one another. The ACO Gravel Stabilisation is perfect for municipal landscaping (e.g. in parks and

cemeteries), on garden paths and patios, yards, car parking areas, driveways and access routes, as well as roofs. The bendable ACO Edging is the ideal accessory for gravel stabilisation to create permanent attractive edges to lawns, flower beds, paths/paved surfaces and patios.



Border profiles
for perfect transition between surfaces

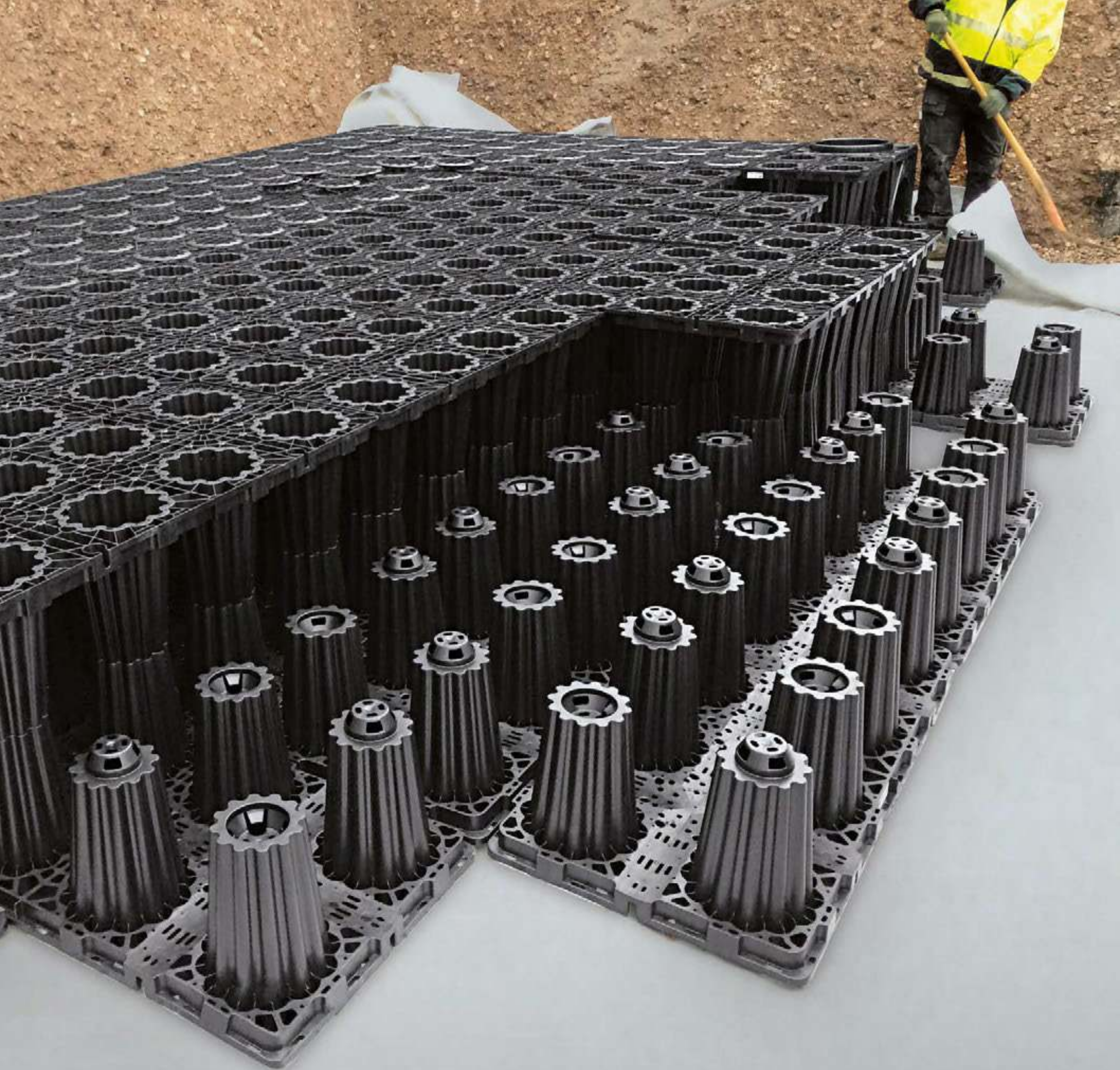

Roof Terrace & Facade
 Kitchen
 Bathroom
 Entrance & Lobby
 Spa & Pool
 Basement
 Parking
 Garden & Landscaping

ACO Stormbrixx SD

Modular infiltration system

Product overview

ACO Stormbrixx is a modular infiltration system made from synthetic materials, which on the one hand provides storage of water from storm water and on the other hand is used to provide infiltration of the storm water. The basis of the system are the building blocks which are laid in bonded patterns using an intelligent snap lock system, and give the overall system its structural rigidity.

The modular ACO Stormbrixx infiltration system reduces transport costs and therefore more than halves CO2 consumption and the storage space required in storerooms and on the construction site compared to other systems.

- Height of 1 layer: 914 mm
- Basic elements/m³: 3
- Volume/basic element: 319 l
- Storage coefficient: 97 %
- Min. cover depth: 0.8 m
- Max. cover depth: 2.0 m
- Tested by MFPA Leipzig



FEEL SAFE WITH US

50
YEARS



ACO Stormbrixx installation video

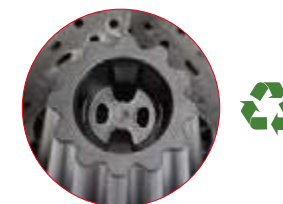

Recyclable polypropylene material provides a robust and corrosion-resistant basis for a long-lasting infiltration system. The basic elements form a loadable structure.



The pillars are also filled with storm water. Small openings at the base of the pillars optimise water treatment in the product.



Basic elements can be cut in half to allow integration into the overall system.

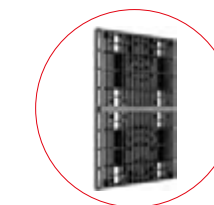

Side panel perimeters for the entire system offer a sound base for laying the geotextile wrapper.



Thanks to the open structure of ACO Stormbrixx, inspection cameras and cleaning devices can have free passage through the system.



ACO Wotan & ACO Standart

Tree protection grills

Product overview

With the tree protection systems WOTAN and Standard ACO fulfills all technical requirements and offers optimal security in the living area of trees in urban areas. Healthy green and good looks: both objectives are optimally achieved with the ACO tree protection systems. The protection grates protect the roots from compression. An adequate oxygen supply as well as ventilation of the root area is fully ensured. Through different design variants or by the installation of ground lights in the tree guard the freedom of design has no limits.

- Different designs
- High variability in shape and size
- Sizes over 4.0 m possible
- Self-supporting without substructure
- Low construction height (6 cm)
- Inner diameter adaptable after the trunk circumference of the tree
- Load capacity up to 50 kN, SLW 30
- Openings for ACO light point possible
- Tree guards available



ACO Tree grill WOTAN
self-supporting without substructure



ACO Tree grill Standart
self-supporting with steel substructure





ACO Uniface cover

Outdoor access covers

Product overview

ACO access covers are a range of high quality access covers which, whilst providing quick and easy access to underground services, enable decorative floor finishes to be maintained with minimal interference. ACO Access Covers are innovative and made of high quality materials. Our complete range of covers is fully certified according to European standards and meets all load, safety and functional requirements.

- Type tested and certified according to EN 1253-4.
- Tested with space for tiles 15 mm (competitors covers tested completely filled with concrete)
- Bolt locked – child safety
- Corrosion resistant
- Small corner parts
- Secure installation – good connection with concrete (profiled frame or anchors)
- Discreet product after installation
- Easy tool for opening and manipulation
- Water-tight and odour-tight

ACO Uniface Stainless Steel



ACO Uniface Alluminium





Roof Terrace & Facade
 Kitchen
 Bathroom
 Entrance & Lobby
 Spa & Pool
 Basement
 Parking
 Garden & Landscaping

ACO Multitop Manhole covers

Product overview

The innovative ACO Multitop system is developed to comply with the modern challenges of drivable areas. The intelligent structure of the components allows the distribution of the dynamic load from the traffic, which guarantees that the cover remains at the same level as the road surface. The flat surface of the installation guarantees safety and comfort for vehicles and passengers.

- Durable and cost-effective solution, 10 year guarantee
- Flat surface – safety and comfort for vehicles and passengers
- Secret bolt locking against vandalism
- Soundproofing sealing in the frame
- Anti slip surface of the cover
- Inscription of a logo on the cover surface



Special anti slip surface, regardless of the direction of traffic

Better ventilation of the canal through large ventilation cross section reduces corrosion



ACO Gully

Point drainage

Product overview

ACO Gully offers point drainage of external areas. The solid cast iron grating allows pedestrian and automotive traffic, as well as reliable locking. This system can be installed in a few steps and meets the highest requirements in terms of processing and design. The cover can only be opened with the aid of a tool and is ideal for use in public areas. A filter bag is available for connection to a pipe infiltration so the water is purified and led into the infiltration.

- Load class B 125 DIN EN 124
- Vandalism- and theft-proof due to the screwless locking Pointlock
- Extremely low component weight compared to conventional concrete products
- Optionally with cast iron grating (EN-GJS) or mesh grating (mesh size: 32 x 10) with integrated, screw-less Pointlock locking system
- With odor trap and bucket made of plastic



Gully made of polymer concrete with cast iron grating and frame (EN-GJS)



Gully made of polymer concrete with mesh grating Maschenrost (galvanized steel MW 32x10 mm) cast iron frame



Top element made of polymer concrete for additional height adjustment, DN/OD 110 pipe outlet connection



Polymer concrete compensating element for adjusting the height of the surface covering

Experience worldwide





Westin Hotel Hamburg

Location: Hamburg, Germany

Architect: Herzog & de Meuron

Year of construction: 2016

ACO Products

- ACO SlotDrain
- ACO PowerDrain
- ACO SK



ACO Solution

The 5-star Westin hotel in Hamburg hosts 244 exclusive design rooms under the roof of the Elbphilharmonie - one of the most bold buildings in the city with impressive contemporary architecture. ACO supported the project with complete solution for surface water management of the facade and landscaping around the building.





Intercontinental Ljubljana

Location: Ljubljana, Slovenia

Architect: OFIS ARHITEKTI d.o.o

Year of construction: 2017

ACO Products

- ACO MultiDrain - line drainage with design gratings
- ACO Monoblock – monolithic drainage channels
- ACO Modular stainless steel channels
- ACO Passavant roof gullies made of cast iron
- ACO Easyflow gullies
- ACO Box channels – stainless steel hygienic drainage
- ACO Hydrojet RAE free-standing grease separator
- ACO Multi-PRO-PE-K pump
- ACO Lipumax P-DA grease separator

ACO Solution

Line drainage of the façade and the surrounding areas is executed with ACO MultiDrain. The Red Dot Design and IF award winning grating is made of stainless steel and contributes to the aesthetic appearance of the architecture. At the same time optimal drainage and comfort for pedestrians is provided.

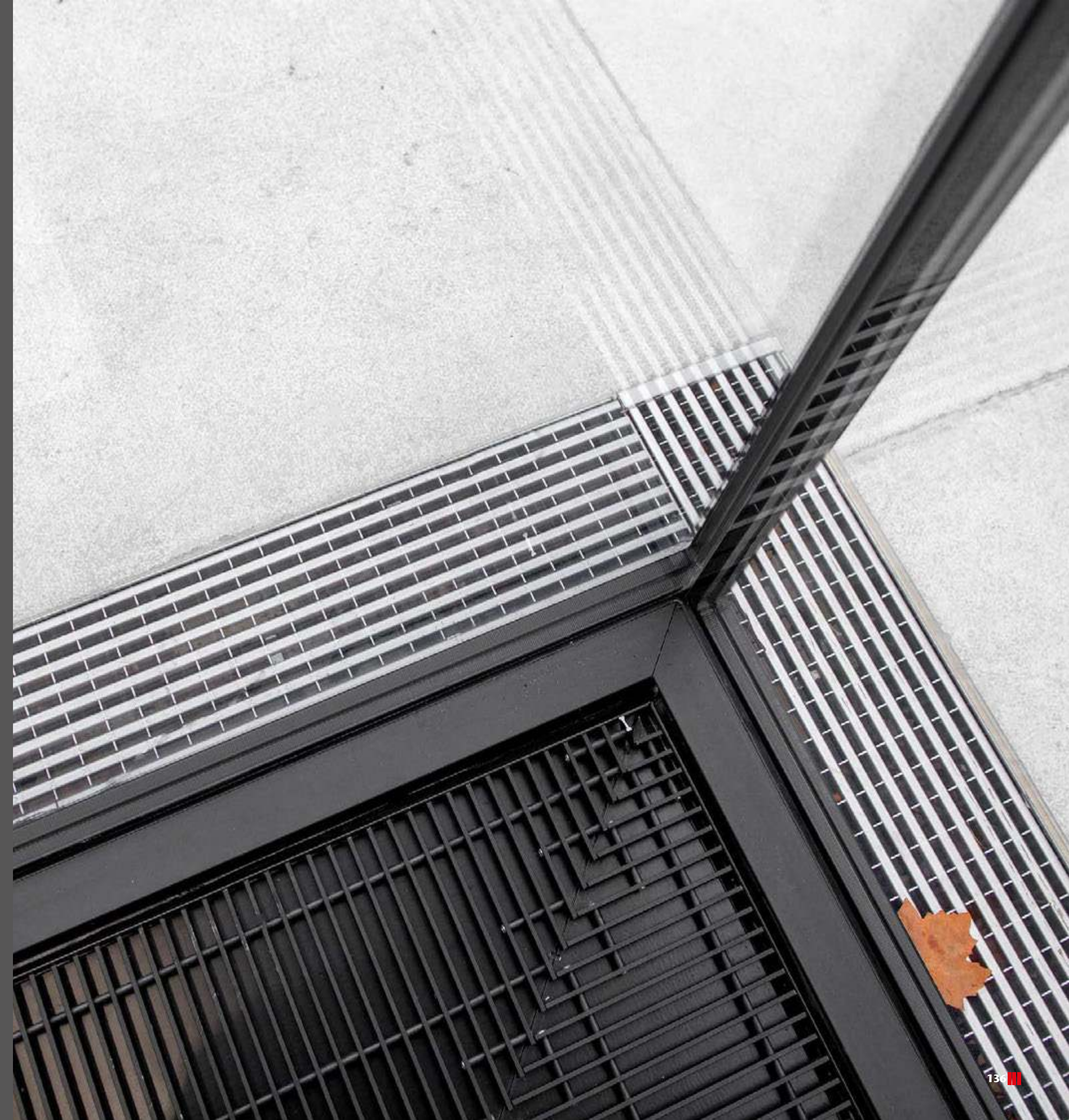



Sense Design Hotel

Location: Bulgaria, Sofia

Architect: Architecture Group Tsonkov

Arch. Simeon Tsonkov

Investor: George Chojev, BLVD Ltd.

Year of construction: 2013

ACO Products

- ACO ShowerDrain



ACO Solution

Sense Design Hotel is located in the very heart of Sofia city, just a few steps from the parliament and the landmark cathedral. It was opened in 2013 when an existing classic residential building was redesigned into a contemporary hotel. The project required compliance with existing pipework of the building. ACO Design team supported the projects with individual measuring of every single shower area and delivering custom made channels. The architect's preference was using ACO ShowerDrain with integrated tile in the cover, in order to achieve visually uninterrupted surface.





Radisson Blu Old Mill Hotel

Location: Serbia, Belgrade

Architect: Graft Architects

Investor: Soravia

Year of construction: 2015

ACO Products

- ACO Profiline - façade drainage
- ACO ShowerDrain
- ACO Stainless steel gullies
- ACO Stainless steel tray channels
- ACO Uniface - access covers
- ACO MultiDrain - line drainage
- ACO XtraDrain - line drainage
- ACO cast iron gully

ACO Solution

An ambitious project of turning the historic “Old Mill” building into a 4 star hotel overlooking the Sava river and centre of Belgrade. Graft Architects have successfully combined the traditional architecture of the existing building, with new materials and modern interior concept, creating a unique experience. The façade with original bricks from the Old Mill was saved intact and merged amazingly well with the modern interior style. In such a concept, ACO products have found the wide use in all the aspects of water management: Bath, Kitchen, Façade, Piazza, Garage, Parking. In such a design, combination of functionality and aesthetics of products was highly required. High quality ACO products with their discreet design were chosen by the architects and proved their value during installation and maintenance.





Intercontinental

Location: Sofia, Bulgaria

Architect: arh. Hristo Kovachev

Year of reconstruction: 2017

ACO Products

- ACO ShowerDrain - line drainage for bathrooms
- ACO MultiDrain - line drainage



ACO Solution

The iconic hotel facing the parliament building in Sofia, Bulgaria was recently acquired by the Intercontinental chain of hotels. Overlooking Narodno Sabranie Square and offering stunning views of Alexander Nevski Cathedral, InterContinental Sofia is the capital's ultimate luxury hotel.

During the renovation of the hotel, ACO supplied high quality line drainage system for the bathrooms. Each solution was chosen in compliance with the design of the bathrooms and the specific needs for installation.





Hotel Eurostar

Location: Madrid, Spain

Architect: R&AS, Carlos Rubio & Enrique Álvarez-Sala

Year of construction: 2008

ACO Products

- ACO MultiDrain



ACO Solutions

The Eurostars Madrid Tower - an acclaimed, prestigious hotel created for clients who love exclusivity. The height makes us unique: the Eurostars Madrid Tower occupies the first 31 floors of the imposing 236-metre-tall SyV Tower.

The SyV Tower was designed by the prestigious architecture studio R&AS run by Carlos Rubio and Enrique Álvarez-Sala and is part of the latest architectural, urban planning and business symbol of Madrid, the Cuatro Torres Business Area. The area around the skyscraper is drained with ACO MultiDrain with cast iron grating.





Falkensteiner Hotel

Location: Serbia, Belgrade

Architect: Atelier Podrecca (Boris Podrecca)

Investor: Alba Invest

Year of construction: 2013

ACO Products

- ACO BrickSlot façade drainage
- ACO Hydrojet OA NG 10 grease separator
- ACO Multi-Star DDP lifting station
- ACO ECO Mobil grease separator
- ACO MultiDrain – line drainage
- ACO Coalisator GG oil separator
- ACO cast iron gully

ACO Solution

Modern 4 star hotel, placed in the business centre of Belgrade, designed by an international star architect Boris Podrecca. Wide application of ACO products has helped the functionality of the hotel, especially with grease separation from the kitchen, where ACO fought to prove the importance of fully automated separators in such applications. The aesthetics feature which was important for the architect, was brought by ACO BrickSlot channels to drain the façade and Multiline channels in the surrounding areas.

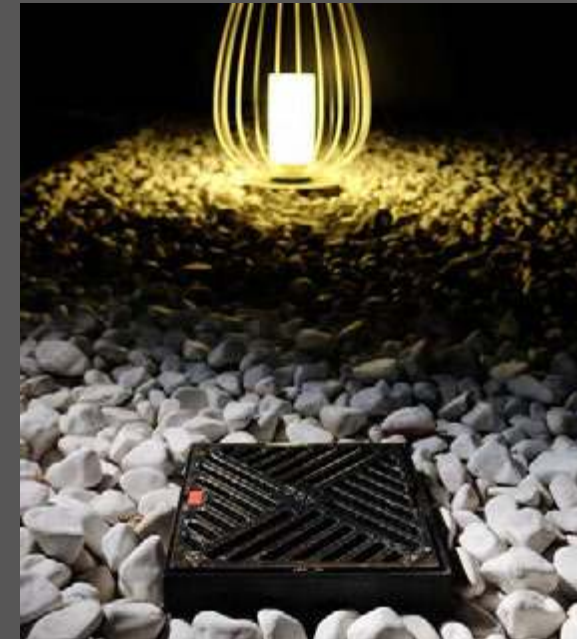



Meydan Hotel and Racecourse

Location: United Arab Emirates, Dubai

Architect: Teoh A Khing

Year of construction: 2013

ACO Products

- ACO Shower Drain
- ACO Box channels with mesh gratings
- ACO Modular channels with mesh gratings
- ACO Access covers
- ACO MultiDrain
- ACO SlotDrain

ACO Solution

The 7.5 million sq. m Meydan Racecourse includes Meydan Marina, The Meydan the world's first 5-star trackside hotel with 285 rooms, 2 race tracks and the Grandstand, which comprises a hotel, restaurants, a racing museum and 72 corporate suites. ACO supported the project with drainage solutions for the landscaping area. High quality hygienic channels were installed in the kitchens.





Agaoglu Maslak Aparthotel

Location: Istanbul, Turkey

Architect: Agaoglu Maslak 1453 Design Team

Year of construction: 2017

ACO Products

- ACO SlotDrain
- ACO MultiDrain
- ACO Stainless steel gullies
- ACO Spin roof gullies
- ACO Access covers
- ACO KerbDrain



ACO Solution

The project Agaoglu Maslak 1453 in Istanbul includes residential area, landscaping and aparthotel. ACO Design team supports the project with hydraulic calculations and product selection. Various types of line drainage systems are installed, depending on the specific requirements of each area - including channels with gratings, slot channels and kerbs with integrated drainage.





Marriott Hotel

Location: Skopje, Macedonia

Architect: Develop Group

Year of construction: 2013

ACO Products:

- ACO ShowerDrain
- ACO ExtraDrain
- ACO Lipumax
- ACO Euroline Supermini
- ACO Spin roof drainage

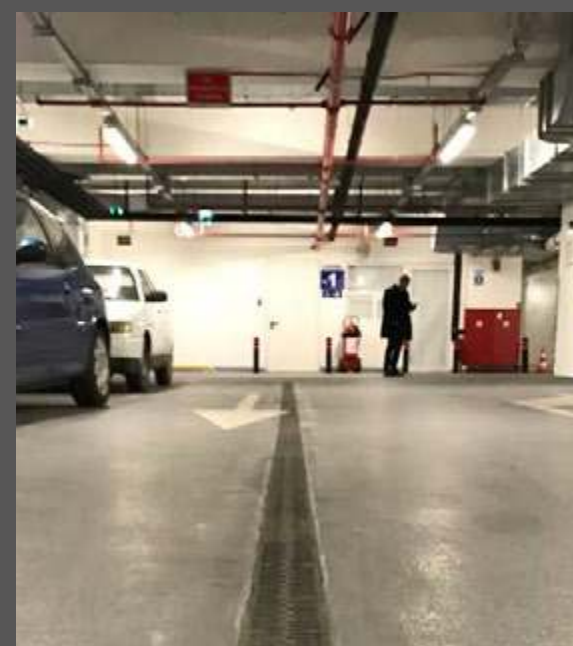

ACO Solution

Marriott hotel in Skopje offers stylish accommodation, friendly service and convenient city centre location. The sophisticated rooms and suits feature scenic views to Macedonia square. ACO supported the reconstruction of the hotel with solutions for external drainage of pedestrian areas around the building, cast iron road gullies, grease separation system for the kitchen and design line drainage for the shower areas in the bathrooms of the hotel.

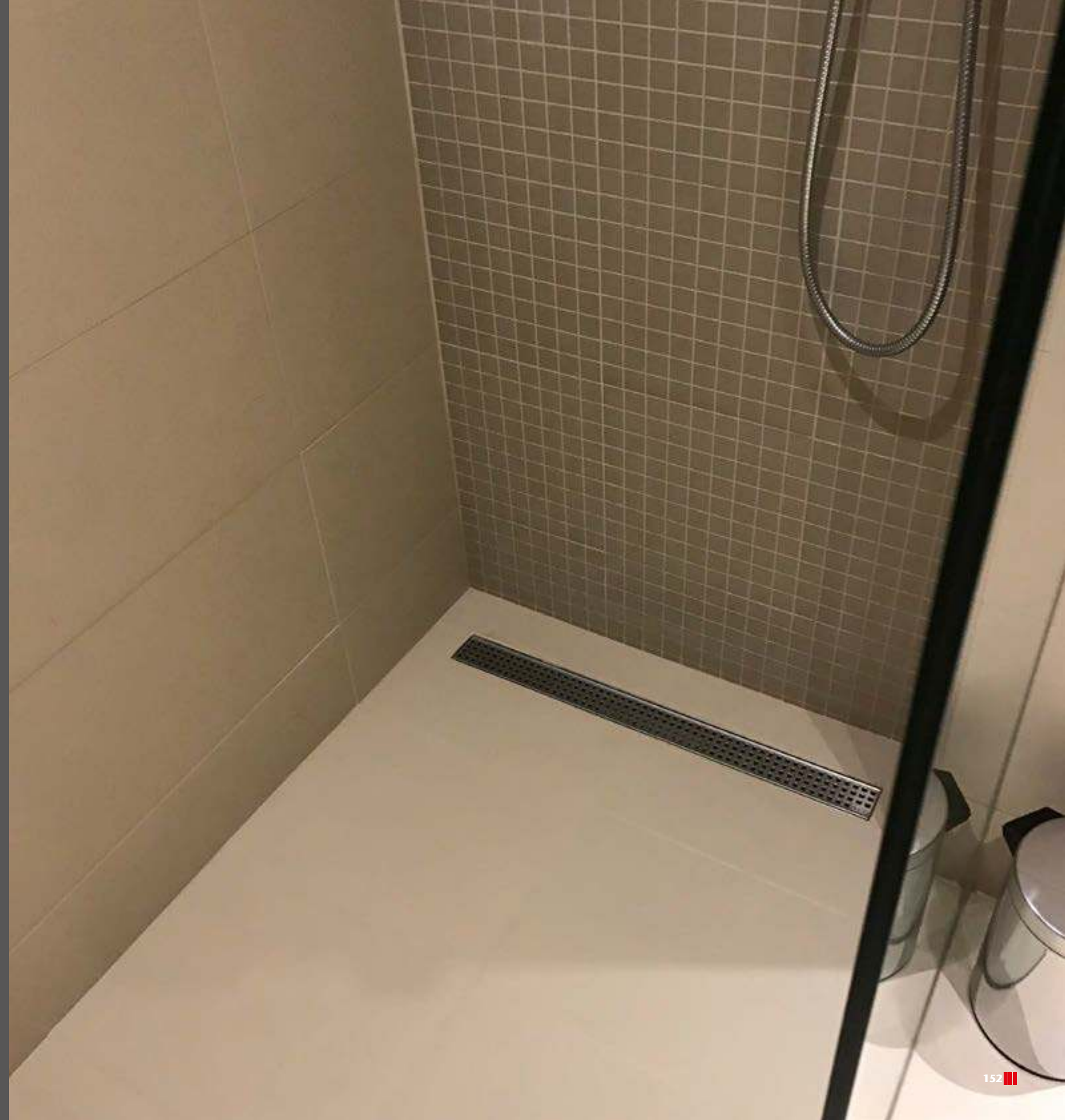



DC Tower Hotel Melia

Location: Vienna, Austria

Architect: Dominique Perrault und
Hoffmann-Janz Architekten

Year of construction: 2013

ACO Products

- ACO Profiline - bespoke stainless steel channels



ACO Solution

Since 2013, the DC Tower 1 has impressively shaped the cityscape of Vienna. The 250-meter-high tower by the French star architect Dominique Perrault is currently the tallest building in Austria.

To meet the demands of the architecture, ACO Profiline channels made of the highest quality V4A stainless steel were manufactured to fit the individual demand of this outstanding project. All channels were dimensioned according to the expected amount of water to protect the building structure and drain the stormwater.

As a sophisticated detail, the facade raises above the skyterrace as a windbreak. As a result, the facade needs drainage on the outer and in addition on the inner side. All channels (more than 600m in total) were produced individually, as the needed to fit around the pillars of the irregular facade construction.

On the ground floor very wide and deep channels run along the facade around the entire building. Another major challenge was to generate a persistent appearance of the longitudinal stainless steel gratings overcoming widths of partly more than 70cm.





Novotel Sofia Hotel

Location: Sofia, Bulgaria

Architect: Markan Project

Year of construction: 2009

ACO Products

- ACO MultiDrain - line drainage
- ACO Cast iron gullies



ACO Solution

This new 4-star business hotel provides latest generation rooms and meeting rooms with state-of-the-art equipment in Sofia's main business district. The close location of the airport and the and views of the city or Vitosha Mountain, it is a pleasure to do business at Novotel.

ACO was involved in the constuction of the hotel for delivering high quality drainage systems for the underground parking.

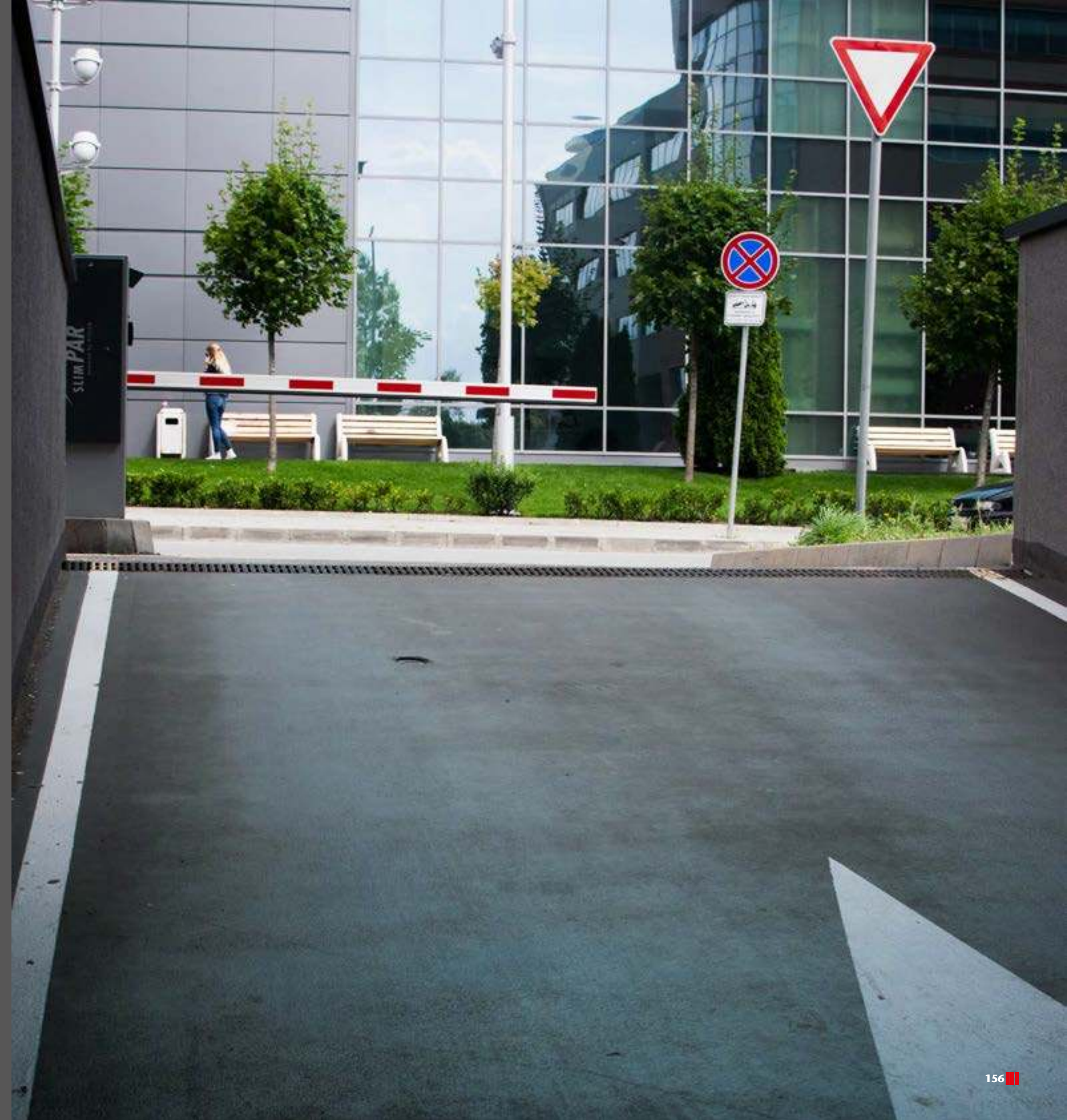



Regent Porto Montenegro

Location: Tivat, Montenegro

Architect: ReardonSmith Architects, London

Investor: Adriatic Marinas

Year of construction: 2014

ACO Products

- ACO Self Euromini with Heelsafe stainless steel grating
- ACO Hexaline Slot
- ACO Cast iron gullies
- ACO Showerdrain E custom made
- ACO HydroJet OA
- ACO MultiDrain
- ACO Combipoint gullies
- ACO BrickSlot
- ACO Access covers

ACO Solution

Regent Porto Montenegro is a luxury 5 star hotel, situated in the Boka Kotorska bay of the Adriatic Coast in Montenegro.

This glamorous retreat was designed by London-based ReardonSmith architects, inspired by the Venetian-style palazzi that dominate the Adriatic coast.

Parisian designer Tino Zervudachi created the graceful interiors which blend perfectly with the arched colonnade and ample terraces of the exterior.

ACO provided complete drainage solutions for the external area, garage, entrances, terrace and balcony as well as custom made ShowerDrain which blended nicely with the exclusive stone design of the bathroom area. Functionality of the kitchen is enhanced by the ACO HydroJet grease separators. Discrete design of numerous ACO TopTek access covers ensured the unique surface design.





Raffles Hotel

Location: Istanbul, Turkey

Architect: Emre Arolat Architects

Year of construction: 2013

ACO Products

- ACO SlotDrain
- ACO MultiDrain
- ACO Hygienic Box channels
- ACO Easyflow
- ACO ShowerDrain

ACO Solution

Raffles hotel is located in Zorlu Center - multiple-use complex on the European side of Istanbul. The center is a four-tower, five-function structure group, including a public square, residential development and office space. On the main pedestrian areas it has been used brickslot design gratings. On the kitchen areas stainless steel box channels has been preferred to provide the highest standards.

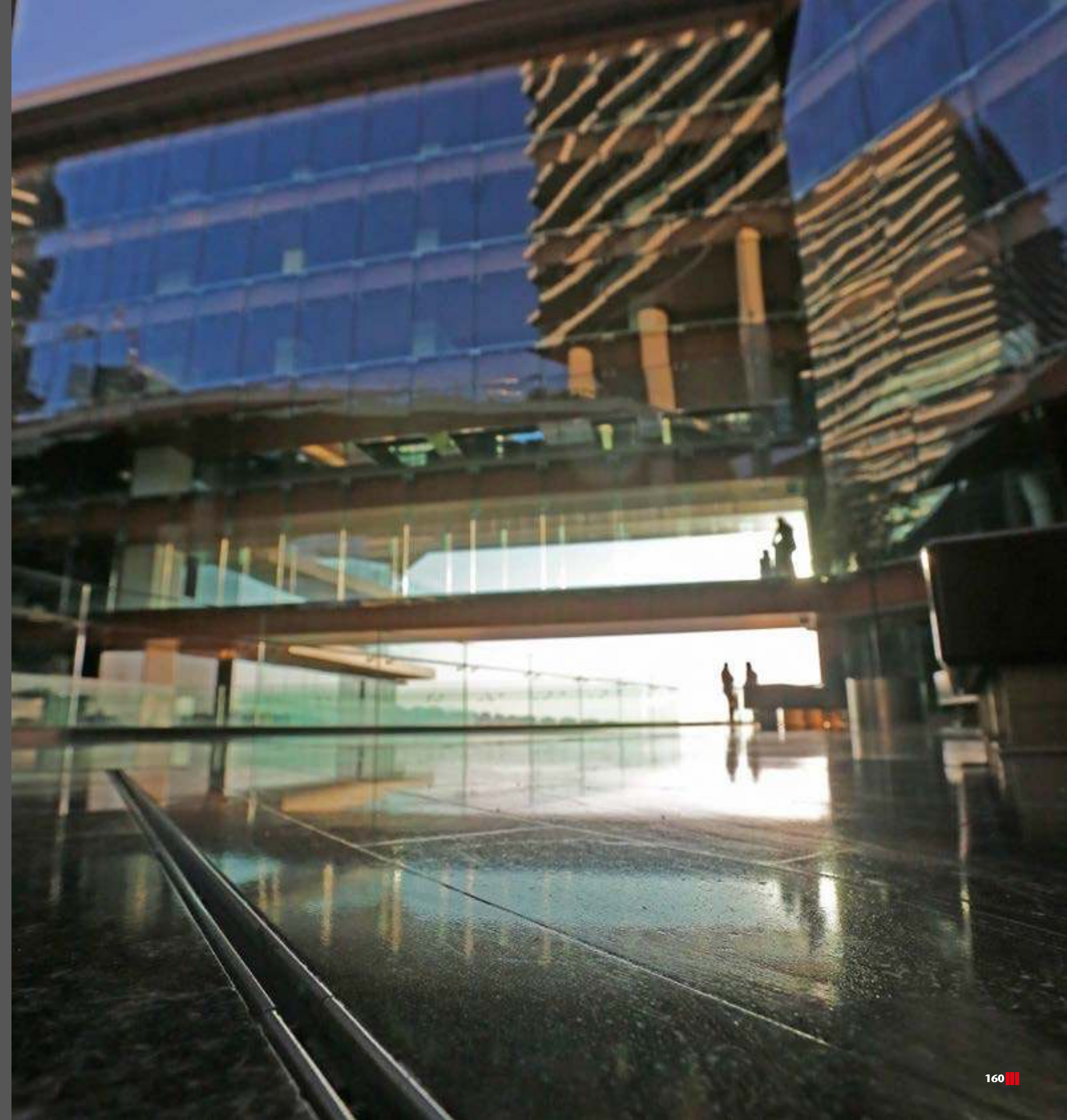



Sheraton Hotel Balkan

Location: Sofia, Bulgaria

Architect: BATES

Year of reconstruction: 2017

ACO Products

- ACO ShowerDrain
- ACO Bath gullies



ACO Solution

Sheraton Hotel Balkan was built in 1956 as part of a new architectural trend: a fusion of classical design and lavish décor, redefining the concept of space. The iconic building of Sofia Hotel Balkan is part of the President's Palace complex and beneath its foundations lies a historical Roman fortress, the remains of which can be seen all around the hotel. As part of the reconstruction of the hotel in 2017 ACO delivers high quality drainage systems for the bathrooms in the hotel.





HolidayInn

Location: Plovdiv, Bulgaria

Architect: RT Consult

Year of construction: 2015

ACO Products

- ACO ShowerDrain - design bath drainage
- ACO Uniface covers - access covers
- ACO Mats - shoescrapers
- ACO Monoblock PD - monolithic line drainage



ACO Solution

HolidayInn is a newly built hotel in the heart of Plovdiv, offering stylish business accommodation and close location to the old town and the ancient ruins of the city. ACO was involved in the project for providing solutions for the bathrooms, spa area, as well as the complete surface water management around the hotel.



Crowne Plaza Hotel

Location: Serbia, Belgrade

Architect: Virgile and Stone, London

Investor: Delta Holding

Year of construction: 2013

ACO Products

- ACO stainless steel roof gullies
- ACO cast iron roof gullies
- ACO ShowerDrain – bath drainage
- ACO Lipurat OAE NG 7 grease separator
- ACO Stainless Steel Tray Channels
- ACO Stainless steel gully
- ACO Wal-Selecta cast iron gullies
- ACO EG 150 gully

ACO Solution

Located in the New Belgrade business town centre, a 4 star hotel Crowne Plaza with 387 rooms and 29 suites, 14 conference rooms and various restaurants and bars, is the city's largest hotel. Completely renovated, previously owned by the Intercontinental Chain, this hotel has a rich history of famous guests residing in presidential suites. ACO was proud to become part of such tradition and offer reliable products and solutions for various applications, like bathrooms, spa, kitchen and roof. ACO Showerdrain E channels were installed in 350 rooms and contributed to their functionality and design. Kitchen drainage and grease separation solutions provided by ACO, largely enhanced the safety and functionality of the food and kitchen operations.

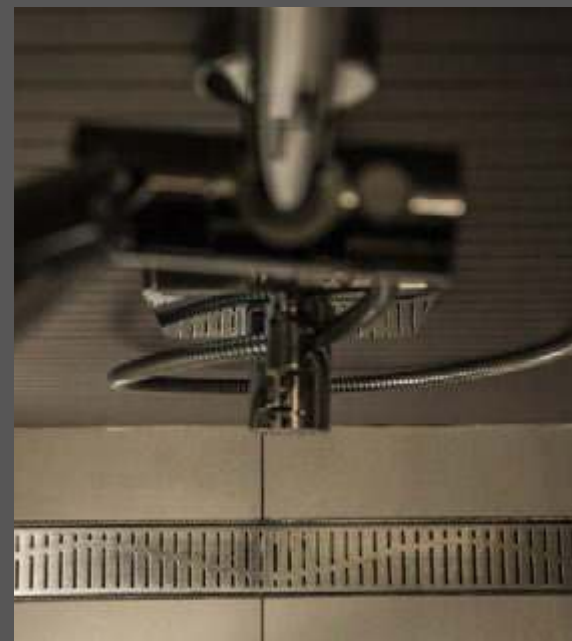



Conrad

Location: Dubai

Architect: Arkins

Year of construction: 2013

ACO Products

- ACO ShowerDrain
- ACO MultiDrain
- ACO Box channels
- ACO Stainless steel gullies

ACO Solution

Located along Sheikh Zayed Road in Dubai, Conrad Dubai is a prestigious mixed use project comprising a luxurious Conrad and premium office space. This 250 M tall landmark tower occupies second to the fourth floor with Grand Ballroom and Ballroom, sixth floor and Mezzanine for Conrad Spa, fine dining restaurants, leisure and meeting facilities, and 24th floor is the Executive Lounge. ACO supports the design and construction of the hotel with solutions for surface water management, as well as internal drainage solutions for the kitchen and the bathrooms.





Lone Hotel

Location: Rovinj, Croatia

Architect: Studio 3LHD

Year of construction: 2011

ACO Products

- ACO SlotDrain – slot line drainage
- ACO MultiDrain – line drainage with design gratings
- ACO Stainless steel channels
- ACO ShowerDrain
- ACO Uniface – access covers
- ACO Spin roof gullies
- ACO Multitop – manhole covers
- ACO OLEOPATOR C – oil separator
- ACO HYDROJET OAE – grease separator
- ACO MULI PE duo AIR - pump

ACO Solution

The first design hotel in Croatia is created by Studio 3LHD from Zagreb. They engage young Croatian designers for the interior design and equipment of the hotel. The cooperation results in the overall visual identity of the hotel with special focus on design features and elements. ACO Design Team supports the planning process with solutions for different areas in the hotel – both interior and landscaping. The ACO SlotDrain line drainage solution is preferred for the outside area because of its discreet opening which does not disturb the surface. The ACO ShowerDrain bath drainage attracted the designers with its aesthetic look and functional features.





Aquahouse Thermal & Beach

Location: St. St. Constantine & Elena, Bulgaria

Architect: STARH, Svetoslav Stanislavov

Investor: St.St. Constantine & Elena Holding

Year of construction: 2018

ACO Products

- ShowerDrain E+
- ShowerDrain C

ACO Solution

Aquahouse Thermal & Spa offers 4 season spa experience by the seaside thanks to the unique combination of sea and thermal water. The complex features 14 pools with different possibilities for treatments and activities.

ACO supported the project with design solutions for drainage of bathrooms and Spa areas, as well as landscaping solutions.





Hotel D-Resort Šibenik

Location: Croatia, Šibenik – Mandalina peninsula

Architect: Nikola Bašić (exterior), Marko Murtić (interior)

Investor: Dogus Holding

Year of construction: 2015

ACO Products

- ACO Lipumax- C - grease separator
- ACO MutliDrain - line drainage
- ACO SlotDrain - slot drainage
- Oleopator- C - oil separator
- ACO Board - grass grid
- ACO Uniface - access covers

ACO Solution

Located in D-Marin Mandalina, the award-winning marina for mega yachts, D-Resort Šibenik is a spectacular design hotel. Thanks to its excellent position, it offers everything you would expect from a vacation by the sea, and the beauty of Šibenik is within easy reach. ACO is present on its project with its wastewater treatment solutions and surface drainage.





Hotel Monte Mulini

Location: Croatia, Rovinj

Architect: Wimberly Allison Tong & Goo

Investor: Maistra d.d.

Year of construction: 2007/8

ACO Products

- ACO ShowerDrain – bath drainage
- ACO Hydrojet – grease separator
- ACO MultiDrain with cast iron grating – line drainage
- ACO MultiDrain with stainless steel grating – line drainage
- ACO Board – grass grid

ACO Solution

Hotel Monte Mulini is exclusive 5 star boutique hotel opened in March 2009. The architecture and design of the hotel, which in spite of modernity fits in with nature, is signed by the WATG - Wimberly Allison Tong & Goo architectural studio. The hotel is part of a protected park called Zlatni rt, right by the sea on the southern shore of Monte Mulini Hill, a few minutes' walk along the coast from the center of Rovinj. ACOs share in creating this luxury hotel was providing top drainage solutions on driveway and reception area in front of the hotel with Multiline channels with Guss gratings, ACO Multiline channels with stainless steel gratings and Areal grass grids on lawn surfaces around the pool, all rooms and suites have ACO ShowerDrain channels in their bathrooms, and kitchen is equipped with ACO Hydrojet grease separator.





Valamar Isabella Island Resort

Location: Croatia, Poreč (St. Nikola Island)

Architect: Mirna Malnar d.i.arh. (Anton d.o.o.)

Investor: Valamar Riviera d.d. Poreč

Year of construction: 2015

ACO Products

- ACO MultiDrain – line drainage
- ACO SK – line drainage
- ACO Euroline Brickslot – slot drainage
- ACO Uniface – access covers
- ACO Uniface – access covers

ACO Solution

Opened in June 2015, Valamar Riviera's luxurious family resort Valamar Isabella Island Resort sits on the island of Sveti Nikola opposite Poreč town. Surface drainage is efficiently solved by the ACO Brickslot system with narrow, decent absorbing grids that blend into the environment by following the facility's lines.

In the prominent position of the pool sunbath and access to the surface drainage, it is emphasized by the ACO Multiline canal with a perforated grating that with its high-gloss stainless steel surface emphasized the luxury of the building itself.

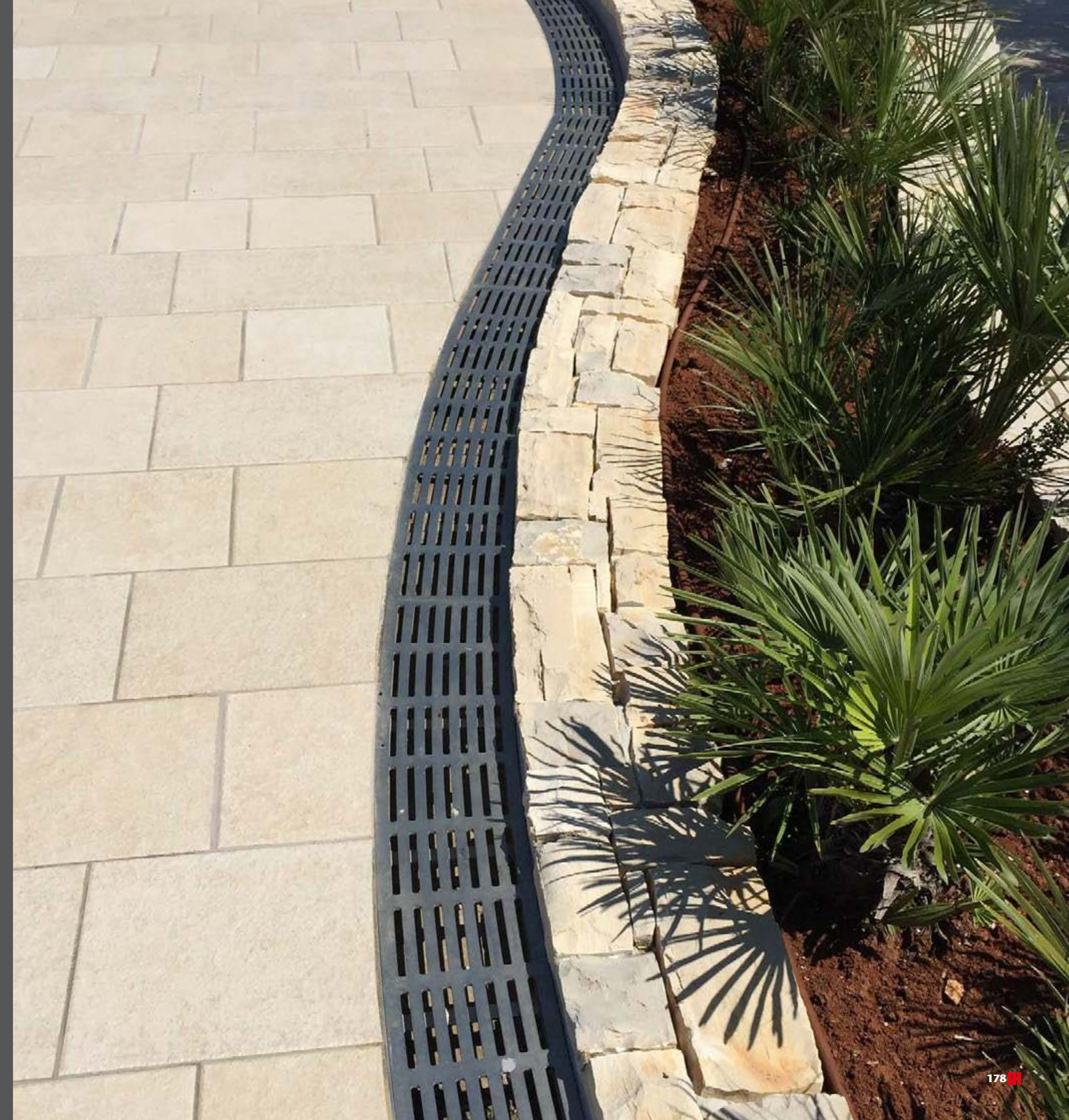



Radisson Blu Resort

Location: Poland, Świnoujście

Architect: Multiselect Zygmunt Baryła

Investor: Radisson Blu Resort

Year of construction: 2017

ACO Products

- ACO Multiline V150S
- ACO Multiline V200S
- ACO Qmax® 225
- ACO SlotTop
- ACO XtraDrain NW 100
- ACO XtraDrain X100C
- ACO Coalisator Oleopator K-PE

ACO Solution

The grand Radisson Blu Resort Hotel in Świnoujście, Poland hotel offers stylish and comfortable accommodation on the sparkling Baltic Sea. ACO supports the projects with complete system solution for surface water management. The design team supported the project hydraulic calculations and complete line drainage system, including channels with gratings, slots and high capacity channels to fit the specific requirements of the different areas surrounding the hotel..





Hotel Bellevue

Location: Lošinj, Croatia

Architect: Andrija Rusan

Year of construction: 2014

ACO Products

- ACO Spin for green roof- gravity roof drainage
- ACO Stainless steel channels
- ACO Stainless steel hygienic gullies
- LIPU-Mobil - mobile grease separator
- ACO Uniface ALU
- ACO Uniface SS
- ACO SK
- ACO MultiDrain
- ACO XtraDrain
- Oleopator-C - grease separator
- ACO Stormbrixx - infiltration system

ACO Solution

The renovation of Bellevue Hotel requires complete redesign of surface water management, which includes creating a modern and sustainable system, having in mind increased capacity of the building and also the raise in precipitation volumes in the area. The project involves a comprehensive range of products inside the building – including kitchen and roof drainage. A system solution for rainwater collection, treatment and infiltration system was designed with special focus was put on sustainability, environmental protection and long-term reliability.





Premier Fort Beach

Location: Sunny beach, Bulgaria

Architect: arch. Vasil Bonev

Year of construction: 2015

ACO Products

- ACO Stainless steel Box Channel
- ACO EG 1 gullies
- ACO Stainless steel Slot Channel
- ACO Uniface covers
- ACO Uniface covers
- ACO Mat shoescrapers
- ACO Euroline line drainage

ACO Solution

Premier Apart Hotel is situated right on the beach with two fresh water swimming pools and a children's swimming pool. ACO supports the project with a complete solution for water management in the kitchen, as well as access covers with intergated pavement inside and outside of the hotel. The drainage of the landscaping area of the hotel is provided by ACO Euroline drainage channels with composite graings.





Amarin

Location: Rovinj, Croatia

Architect: Studio UP

Year of construction: 2017

ACO Products

- ACO MultiDrain - line drainage with design gratings
- ACO Monoblock - monolithic drainage channels
- ACO Uniface covers - access covers
- ACO FHD Gully - point drainage
- ACO ShowerDrain - design bath drainage
- ACO Self XtraDrain - line drainage
- ACO Self Hexaline - line drainage for pedestrian areas
- ACO Box hygienic channel
- ACO Lipumax - grease separator
- ACO Lipumax-P - grease separator

ACO Solution

Family Hotel Amarin is located in a thick pine forest, on the eastern edge of the Monsena-Valdalisio area, on a peninsula with views of Rovinj, Venice and Figarola Island.

This hotel is rightfully named "family" due to 280 accommodation units mostly interconnected by doors, offering a magnificent view of the Adriatic sea and the old town center of Rovinj, which is only a couple of minutes' drive away. The pebbly and rocky beach below the hotel is one kilometer long, but most guests are bound to choose one of the seven attractive pools or the lazy river for their swim. A 1,500 square-meter wellness and spa zone and six catering establishments are also located in the hotel, and besides numerous playgrounds and playrooms, the hotel also have the original Amarin Kids program, developed in collaboration with a team of top child psychologists. A truly ideal place for a carefree family holiday with style, from which boredom is strictly banned.





Bor

Location: Sunny beach, Bulgaria

Architect: Arch View Gradinarska

Year of construction: 2015

ACO Products

- ACO Stainless steel Box Channel
- ACO EG 1 gullies
- ACO Stainless steel Slot Channel
- ACO ECO Mobil
- ACO Uniface covers
- ACO Uniface covers

ACO Solution

The reconstruction of the hotel includes modernization of the Spa & Pool area, as well as the interior of the hotel and the kitchen facilities. ACO supports the project with high quality drainage and waste water treatment systems for the kitchen area, as well as drainage solutions for the restaurant terrace and landscaping areas. High quality access covers with integrated floor covering are installed both in the interior and exterior of the hotel.





Globetrotter Lodge

Location: Ascheffel, Germany

Architect: Moths Architekten

Year of construction: 2014

ACO Products

- ACO Profiline
- ACO ShowerDrain
- ACO Vario
- ACO Lightshafts



ACO Solution

The Globetrotter Lodge in Ascheffel, Germany offers modern comfort in a natural environment. The hotel building, as well as the 23-meter observation tower feature natural wood lamella facades, teak surfaces, nature motifs on the walls, hardwood floors and floor-to-ceiling windows in front of the generous wooden terrace. ACO supported the architect to ensure the drainage of surfaces, considering the special requirements of the project. Based on detailed hydraulic calculations, the size and structure of the catchment areas and the expected rainfall intensity - the complete drainage layout was designed. In addition to the facade drainage, the system solution was completed with bathroom drainage, lightshafts and shoescapers.





Zámek Valeč

Location: Czech Republic, Valeč

Investor: V-Stav

Year of construction: 2014-2017

ACO Products

- ACO ShowerDrain C
- ACO Hygienic modular channel, gully -125
- ACO Slot channels - 8 mm
- ACO MultiDrain

ACO Solution

The design project involved reviving the Renaissance chateau into a modern wellness hotels. ACO supports the project with custom made stainless steel channels for the pool as well as design shower drainage of the spa and the baths. Besides the drainage in the interior of the hotel, the outside area, including the parking lot and the landscaping have line drainage ACO MultiDrain installed.

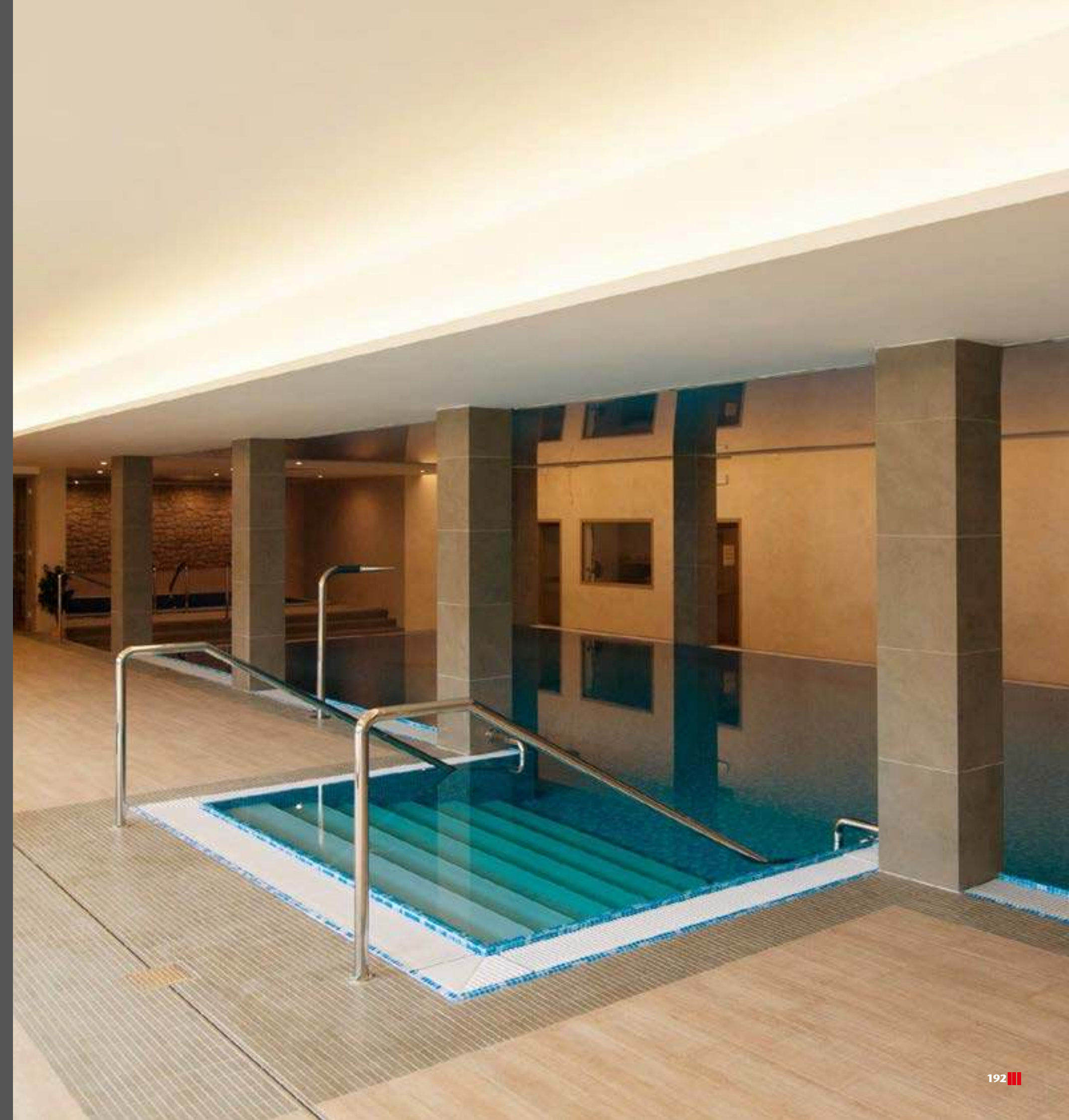
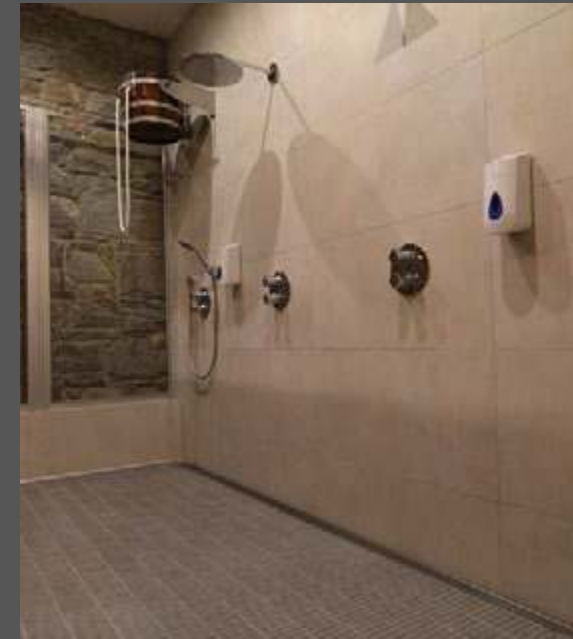



Hotel Krasicki

Location: Poland, Lidzbark Warmiński

Architect: AMCO Olsztyn

Investor: Hotel Krasicki

Year of construction: 2011

ACO Products

- ACO ShowerDrain E
- ACO XtraDrain X100C
- ACO Easyflow

ACO Solution

Set in a redbrick waterfront mansion, this stately hotel is next to the 14th-century Olsztyn Castle. Formerly a bishop residence, the building is redesigned into an artistic modern spa hotel. Natural stone in bathrooms and spa area is highlighted with ACO ShowerDrain channels and design gullies. Line drainage ACO XtraDrain is installed in the external area around the hotel.





Kempinski Grand Arena

Location: Bansko, Bulgaria

Architect: Arca Studio

Year of construction: 2005

ACO Products

- ACO Uniface - access covers
- ACO XtraDrain - line drainage

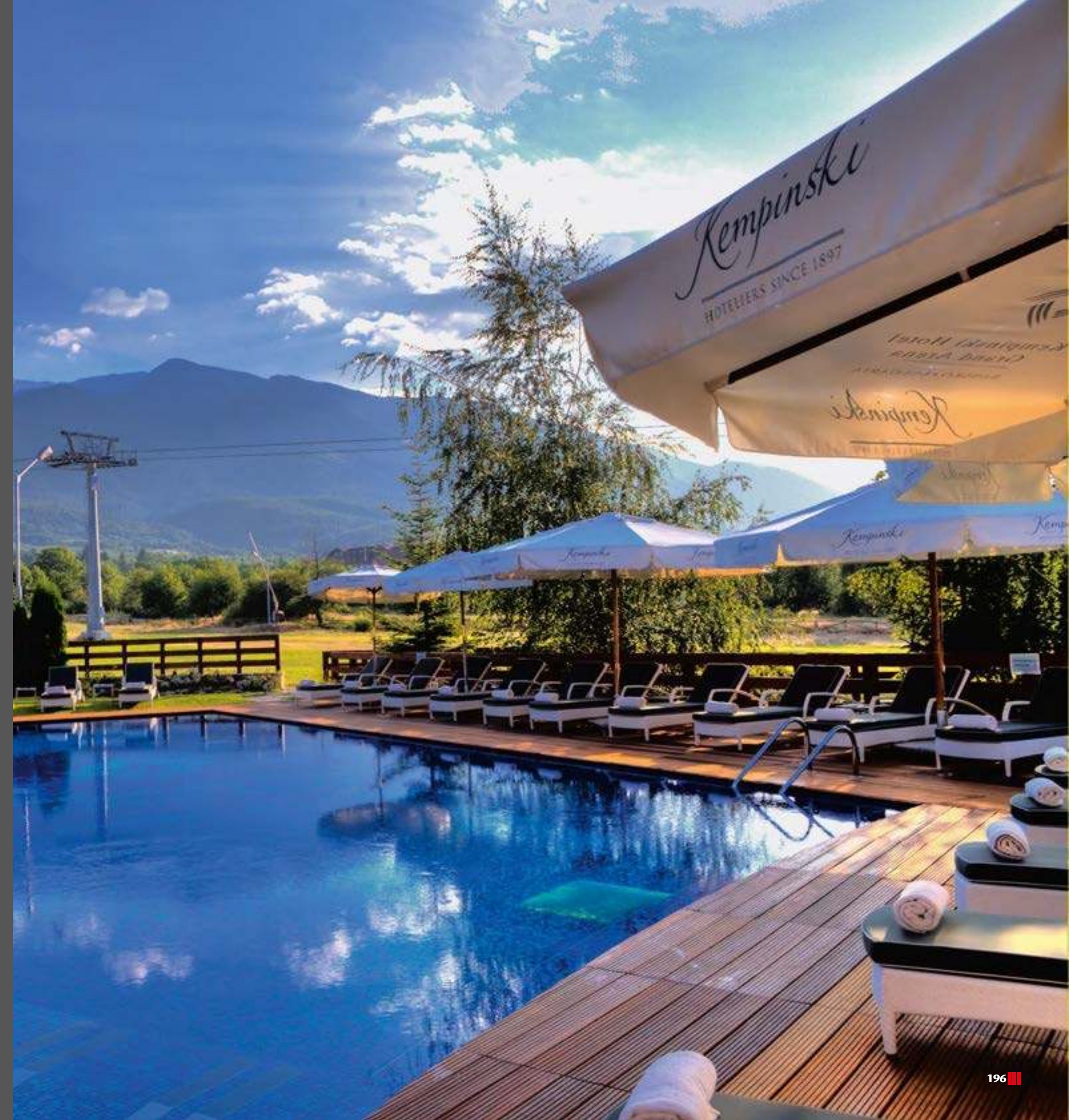

ACO Solution

Kempinski Grand Arena is a landmark in the biggest ski resort in Bulgaria – Bansko. The project executed in 2005 consists of 160 luxury rooms, internal and external pools, remarkable spa area and multiple restaurants. The alpine architecture of the hotel corresponds to the magnificent mountain landscape.

Located right next to the gondola, the hotel offers year-round experience for skiers and mountain lovers. ACO supports the project with solutions for gardens the landscaping around the hotel.



Therme Oberlaa

Location: Vienna, Austria

Architect: 4a Architekten

Year of construction: 2010

ACO Products

- ACO Slot channels
- ACO Floor gullies
- ACO ShowerDrain

ACO Solution

Only three impressive numbers give a first clear impression of a gigantic recreation area right in Vienna: 26 different pools, 24 different sauna types and a capacity of up to 6.000 guests per day. Besides recreation in huge dimensions, architecture and design played a major role when Therme Oberlaa was built and finally opened its doors in autumn 2010.

For safe operation, drainage is a key element to consider. Especially in areas where people walk barefoot. ACO slot channels made of stainless steel were chosen as an excellent solution to be in accordance with both safety and aesthetic demands. A narrow slot with still great water intake and very decent optical appearance collects and takes the water to the gully. The gully top was covered with the respective tiles as well to keep the homogenous surface design.

ACO solutions can also be found in the showering areas, where ACO shower channels were installed to keep a barrier free and clean surrounding.





Gazprom complex of hotels and cable ways

Location: Russia, Sochi

Investor: Rosengineering company

Year of construction: 2013

ACO Products

- ACO Multiline V100
- ACO Multiline V150
- ACO Multiline V200



ACO Solution

The complex of hotels and cable ways Gazprom is located on the crest of the south-west extremity of Psekhako ridge at height more 1430m in the Adler in Sochi in Krasnodar region. The hotel complex represents composition of the buildings executed in original motives of modern architecture. The serious surveying works were preceded to deliveries to this object because a seismicity of the area its location makes 9 points, and for climate the raised snow and wind loadings are characteristic. In 2009 specialists of ACO technical department together with the Rosengineering company developed project documentation about installation of drainage systems in the territory of complex. The choice of the drainage ACO Multiline system which became result of work of designers and ACO Russia technical specialists. ACO Multiline system is ideally adapted for changing atmospheric conditions in Sochi.





At the Park Hotel

Location: Baden, Austria

Architect: Roland Nemetz

Year of construction: 2014

ACO Products

- ACO Uniface - access covers



ACO Solution

The At the Park Hotel is based in the historic city center of Baden right next to the enchanting "Kurpark". Since the 1970s it is in the hands of a hoteliers family. Back then it was bought by the grandfather of the current hotel director. When the young generation took over the family business, it was also the right occasion for a complete but gentle renovation.

Utilizing the beauty of the green park areas around the building for the guests was one target. The other one was to keep some decent elements of the past and the family history. It should be a mixture of fine etiquette and familial easiness. The refurbishment was without any doubt a challenging task for the architect – the current hotel directors father. The entrance hall was lowered by one meter, heavy glass panels were installed to open the facade to the park and the nice completely new terrace. The old pool was exchanged by an excellent vinothèque and a lot of artwork and extraordinary carpets found their way into the hotel.

By bringing new technology standards into the hotel, the necessity of "hiding" the access to them underneath the flooring came up. First priority was to keep the homogenous surface design of the precious wooden and tiled floors. This is where ACO was able to contribute with its solution of access covers.

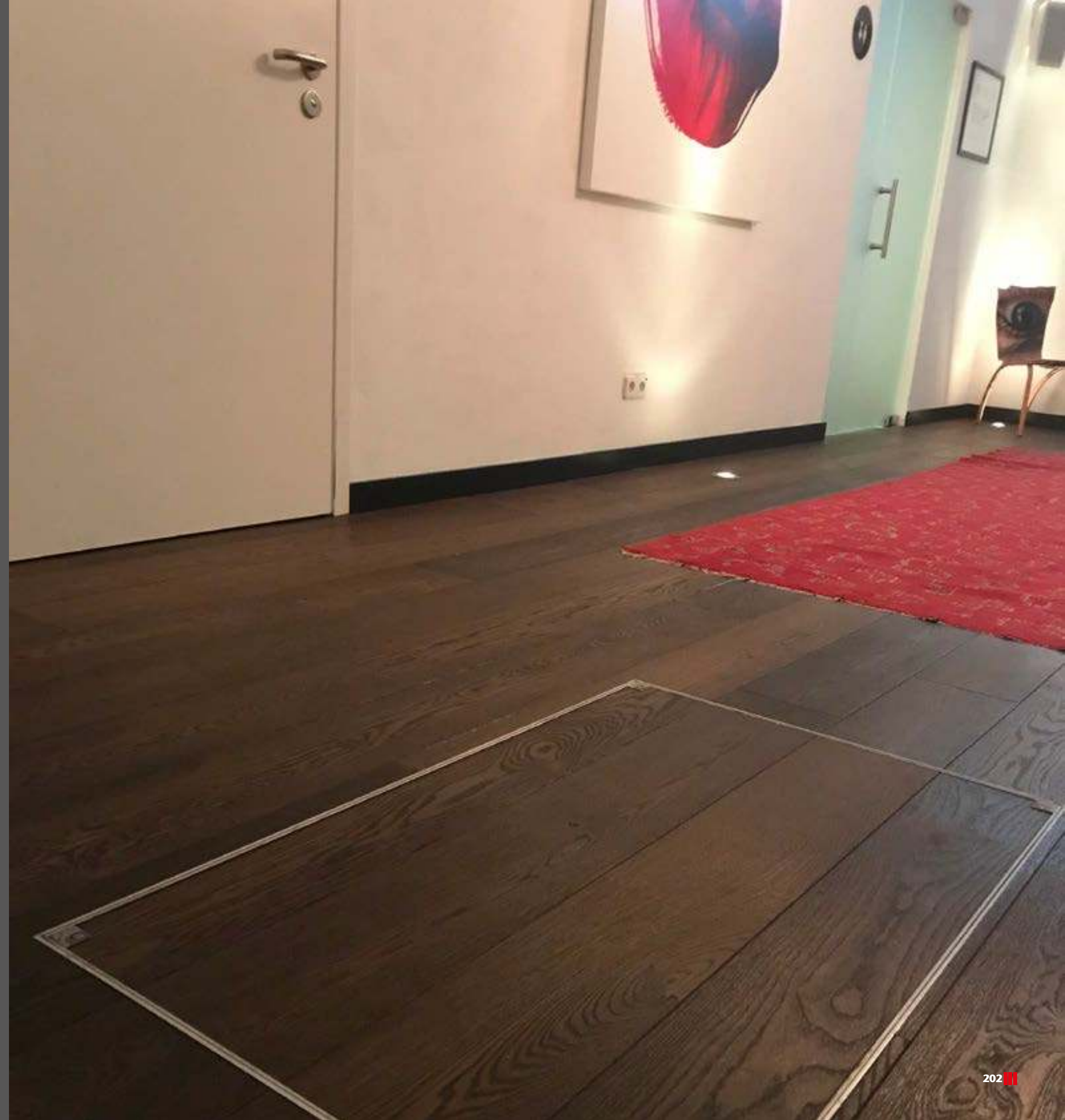



Boutique hotel Chateau Herálec

Location: Herálec, Czech Republic

Investor: Kaspers

Year of reconstruction: 2004

ACO Products

- ACO SK - line drainage
- ACO XtraDrain - line drainage
- ACO Stainless steel bespoke channels



ACO Solution

The walls of Chateau Herálec are dated back to the 13th century. The historic building was owned by different noble families in time. In 2004 it was turned into a luxury spa hotel and has achieved its new dignified existence as a five-star Boutique Hotel & Spa by L'Occitane.

ACO supported the project of reconstruction with delivering solutions for the garden and landscaping areas, as well as custom-made drainage for the spa and pool area.





Burj Al Arab

Location: Dubai

Architect: Atkins, lead by Tom Wright

Year of reconstruction: 1999

ACO Products

- ACO Custom drainage solutions for kitchen
- ACO Custom drainage solutions for helicopter landing pad



ACO Solution

Consistently voted the world's most luxurious hotel, Burj Al Arab and its stunning hotel interior design is the icon of Dubai. With a height of 321 meters it is the tallest all-suite hotel in the world. Burj Al Arab is world's only skyscraper built on an artificial island, the building stands island on the Persian Gulf, 280 m from Jumeirah beach and is connected to the mainland by a private curving bridge. The building is specially built there in order to avoid its shadow covering the beach. There are six restaurants for guests to choose from, including Al Muntaha (The Ultimate) recognized as one of the finest restaurants globally and located 200 meters above the Persian Gulf, offering a breathtaking view. One of the iconic features of Burj Al Arab is that cantilevered platform near the roof, the platform is hovering at a height of 210 m above ground and is being used as a helipad. ACO contributed to the highest class service with custom designed line drainage solution of the helicopter landing pad as well with custom grease separation systems for the restaurant kitchens.



ACO Solutions for Hotels and Resorts

Helping create signature hotels worldwide

